

W O O D & P E T

ACOUSTIC PANELS
WOOD & PET
CATALOGUE

carlos natal®
feeling beyond quality

www.carlosnatal.pt



**Aesthetics,
acoustics, balance.**

**Estética,
acústica, equilíbrio.**



SLATTED PANEL IN NATURAL WOOD

The perfect combination of the acoustic performance of pet panels and the natural, organic look of wood. A versatile solution that adapts to any space, allowing you to create environments full of comfort and sophistication.

PAINEL RIPADO DE MADEIRA NATURAL

A combinação perfeita entre a performance acústica das placas PET e o aspecto natural e orgânico da madeira. Uma solução adaptável a qualquer espaço e que permite criar ambientes repletos de conforto e sofisticação.



**FORESTS
FOR ALL
FOREVER**

STANDARD
100

20230K1743
AITEX

WWW.OEKO-TEX.COM

AEN-COC-001396







COMPOSITION COMPOSIÇÃO

100% poliéster PET (60% fibra PET reciclada + 40% fibra PET virgem) 9mm

A base em PET do painel vai absorver e provocar a dispersão das ondas sonoras

MDF de baixa densidade

O formato ripado do MDF actua como difusor do ruído

Folha de madeira natural

Através da utilização de madeira verdadeira como matéria-prima, e recorrendo à tecnologia de biónica e desenho 3D, foi possível desenvolver um novo conceito de painel acústico decorativo.



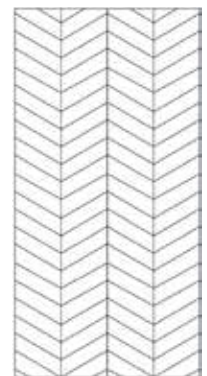

FISHBONE 1*

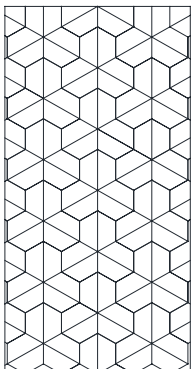

CLOVER*



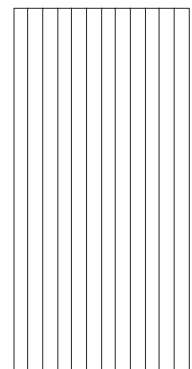

STRIPES 1*





Where comfort
meets nature.

Onde o conforto
encontra a natureza.

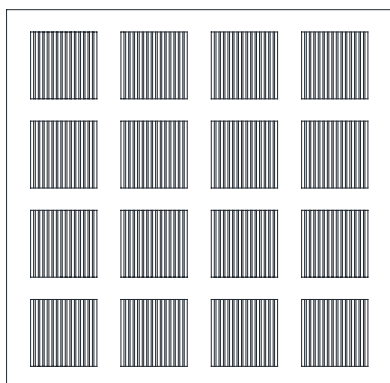

GRID



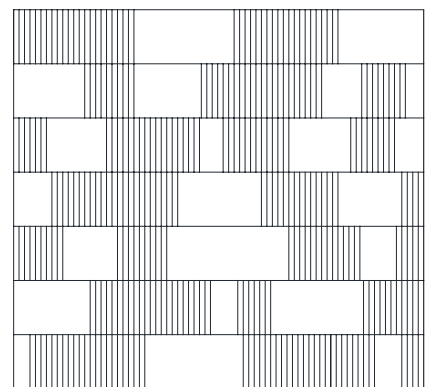

MATRIX

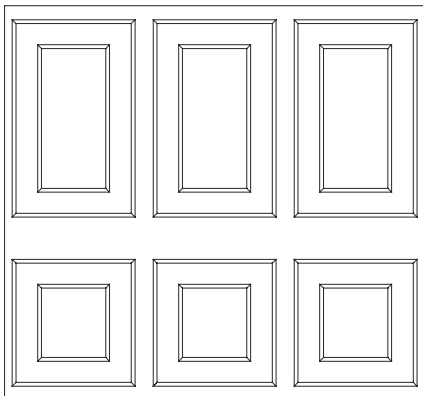

DISPLAY



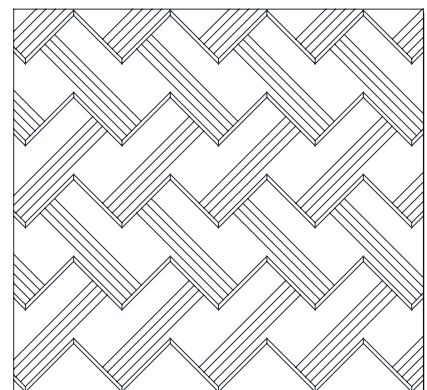

OBLIQUE 2

SLAT COLOURS

CORES DO RIPADO

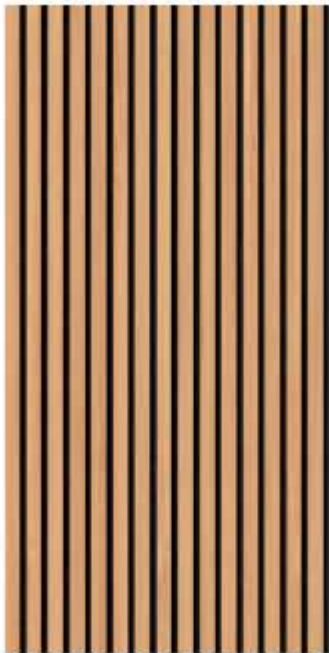

Faia

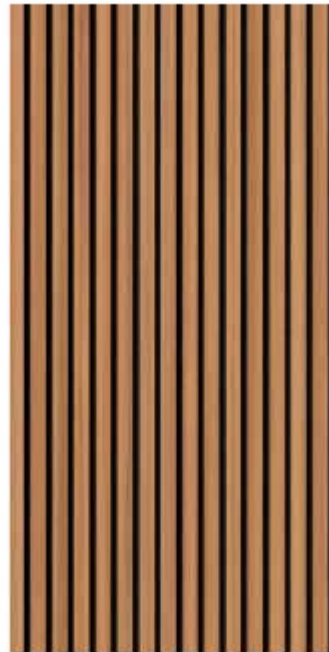

Alvarinho

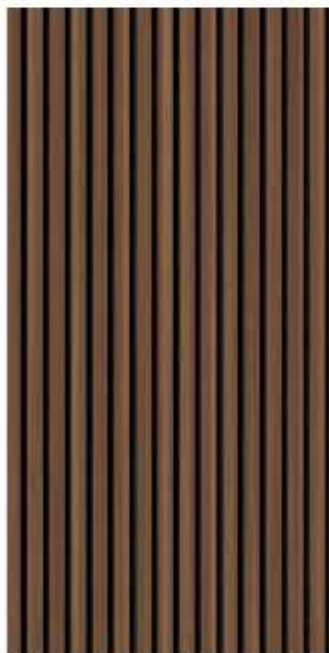

Nogueira



Wengue



STANDARD PANELS PAINÉIS STANDARD

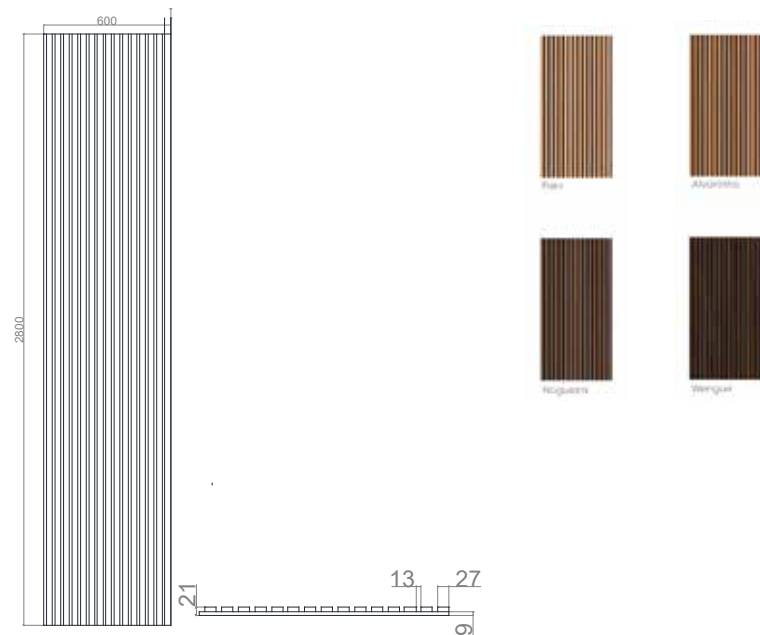

Ripas folheadas nas 3 faces para máxima semelhança com madeira maciça

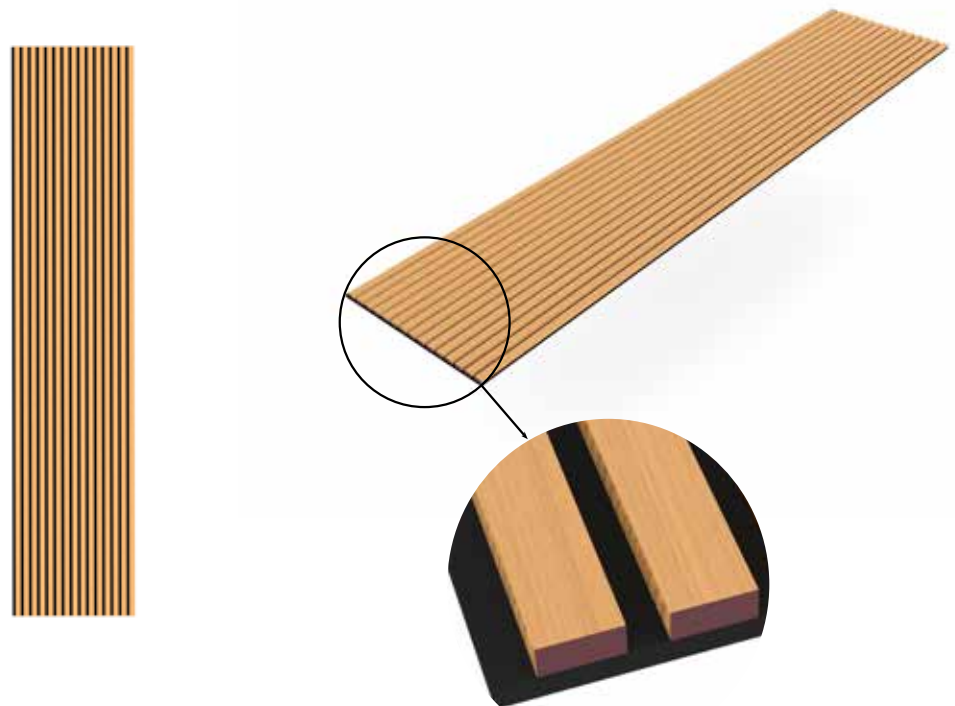

	Ref	Composition	Panel Dimensions	PET Specs	Fire Resistance	Acoustic Performance
Ripado de Madeira FR Folheado 3 Faces (PET Preto)	614	Wood wrapped MDF slats + PET panel	2800 * 600 * 21 mm 168m ² /panel	black 9 mm 1300 g/m ²	EN 13501 B-s1-d0	NRC ≈ 0.80

STANDARD PANELS PAINÉIS STANDARD

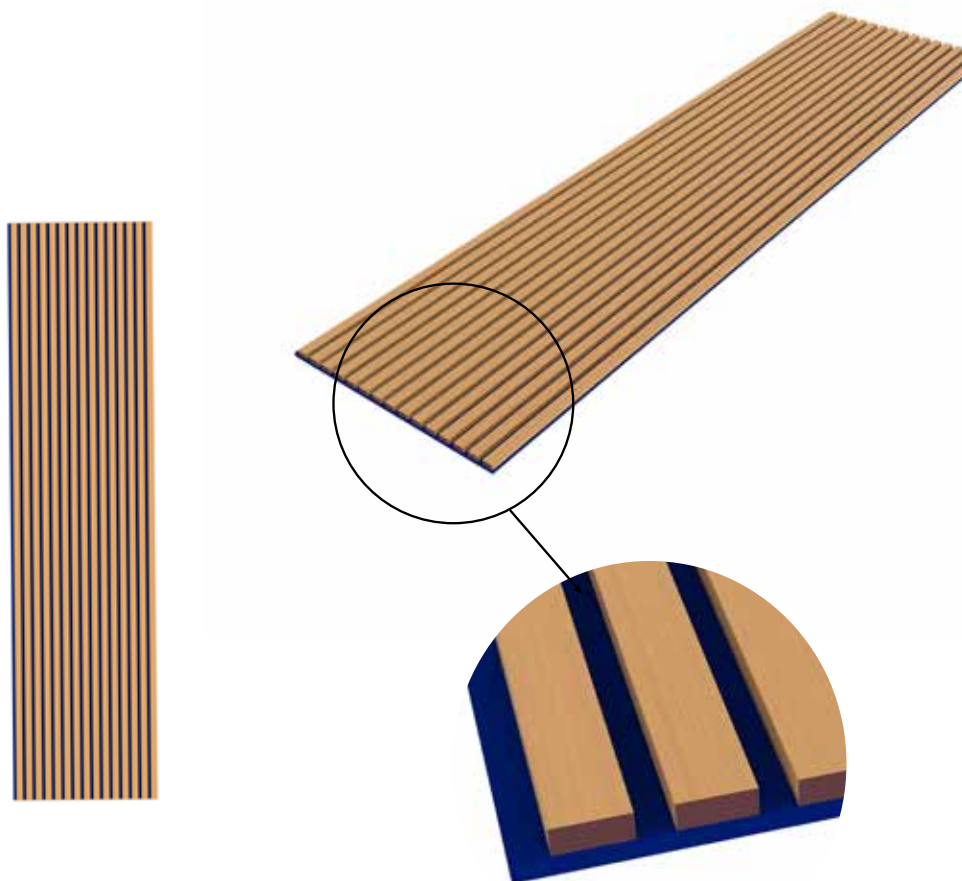
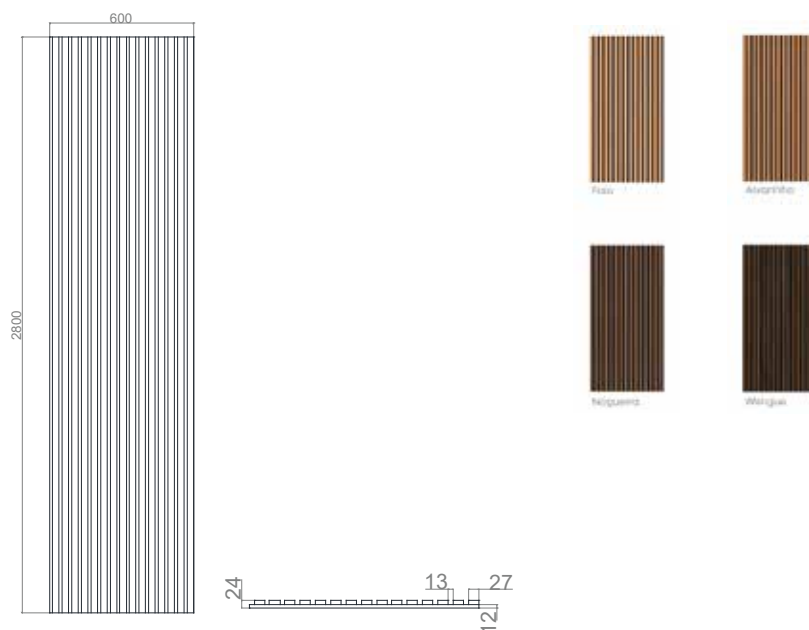

	Ref	Composition	Panel Dimensions	PET Specs	Fire Resistance	Acoustic Performance
Ripado de Madeira FR Folheado 3 Faces (PET Cores)	619	Wood wrapped MDF slats + PET panel	2400 * 600 * 24 mm 144m2/panel	33 colours 12 mm 2400 g/m2	EN 13501 B-s1-d0	NRC ≈ 0.80



STANDARD PANELS PAINÉIS STANDARD

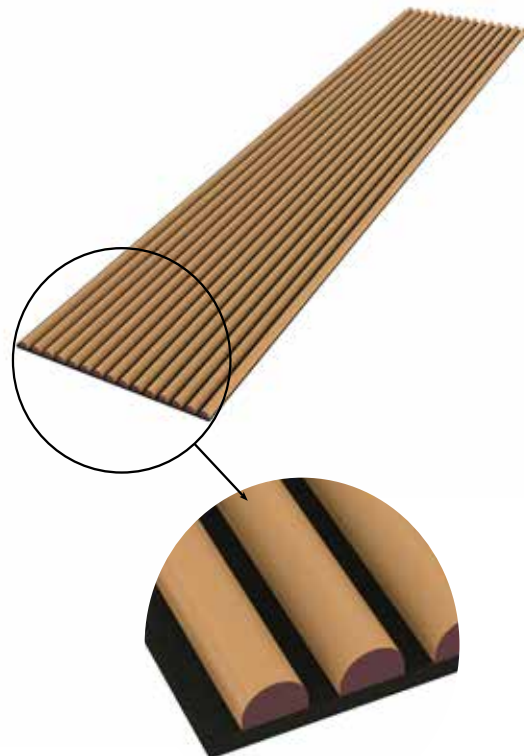
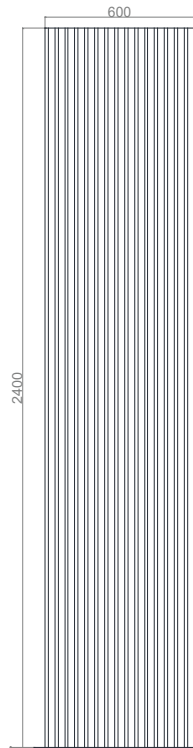

	Ref	Composition	Panel Dimensions	PET Specs	Fire Resistance	Acoustic Performance
Ripado de Madeira FR 1/2 cana (PET Preto)	615	Wood wrapped round MDF slats + PET panel	2800 * 600 * 24 mm 168m ² /panel	black 9 mm 1300 g/m ²	EN 13501 B-s1-d0	NRC ≈ 0.80

STANDARD PANELS PAINÉIS STANDARD

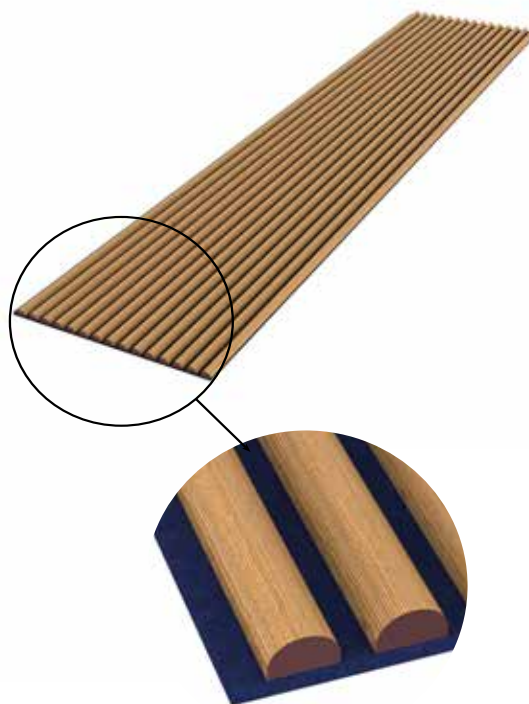
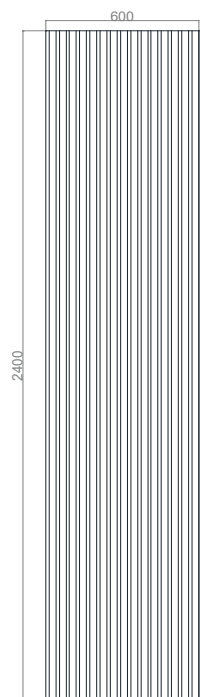

	Ref	Composition	Panel Dimensions	PET Specs	Fire Resistance	Acoustic Performance
Ripado de Madeira FR 1/2 Cana (PET Cores)	620	Wood wrapped round MDF slats + PET panel	2400 * 600 * 27 mm 1.44m2/panel	33 colours 12 mm 2400 g/m2	EN 13501 B-s1-d0	NRC ≈ 0.80



STANDARD PANELS PAINÉIS STANDARD

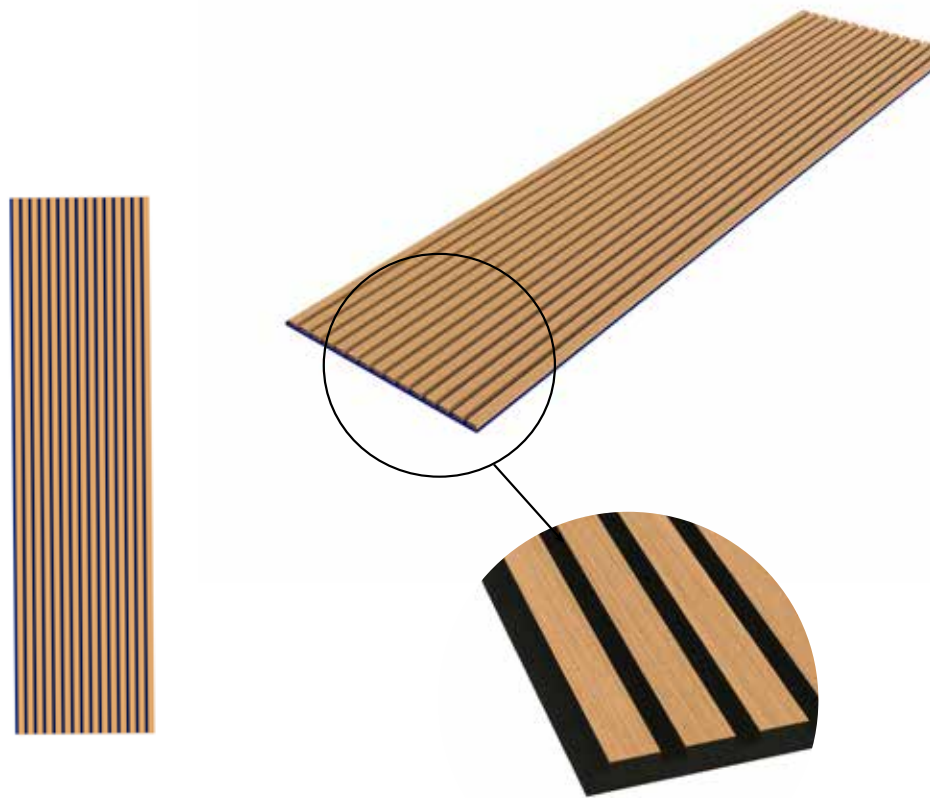
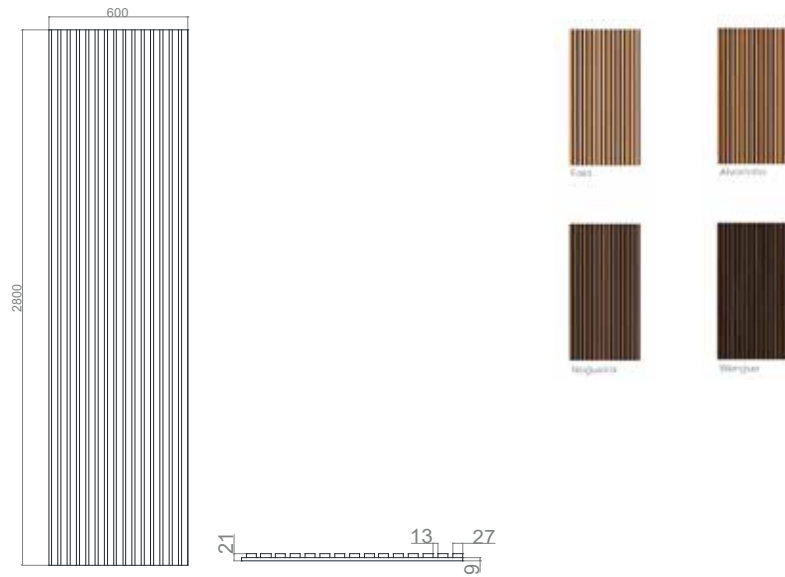

	Ref	Composition	Panel Dimensions	PET Specs	Fire Resistance	Acoustic Performance
Ripado de Madeira Folheado 1 Face (PET Preto)	618	Wood laminated MDF slats + PET panel	2800 * 600 * 21 mm 1.68m ² /panel	black 9 mm 1300 g/m ²	x	NRC ≈ 0.80

STANDARD PANELS PAINÉIS STANDARD

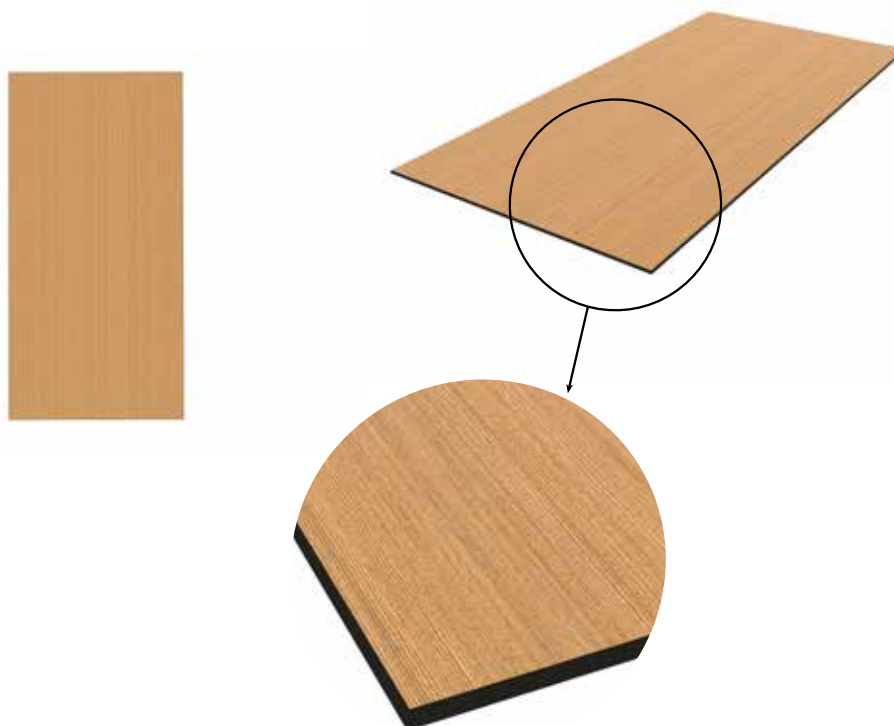

	Ref	Composition	Panel Dimensions	PET Specs	Fire Resistance	Acoustic Performance
Folheado de Madeira 1 Face (PET Preto)	616	Wood veneer + PET panel	2440 * 1220 * 12 mm 2.98m2/panel	black 12 mm 1900 g/m2	X	NRC ≈ 0.55



STANDARD PANELS PAINÉIS STANDARD

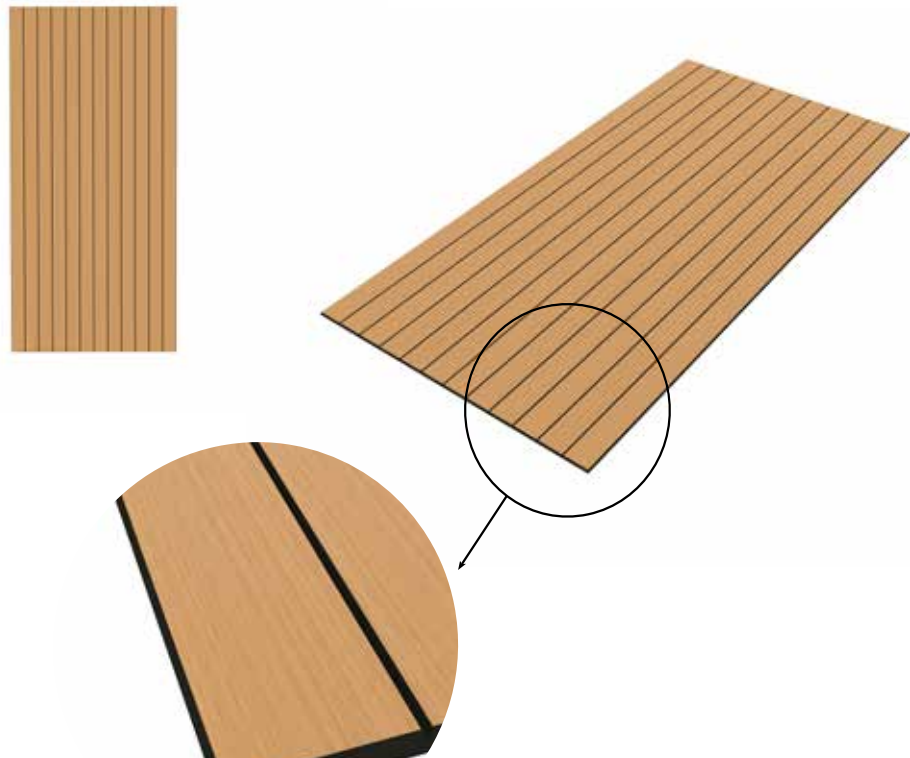
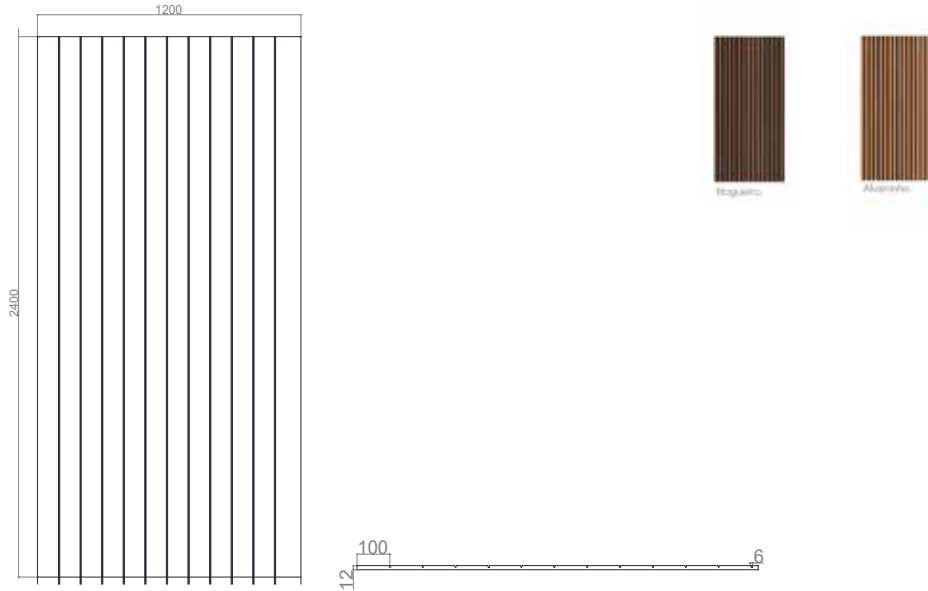

	Ref	Composition	Panel Dimensions	PET Specs	Fire Resistance	Acoustic Performance
Folheado Madeira Bisel 30°/30° mm (PET Preto)	621	Wood veneer + PET panel	2400 * 1200 * 12 mm 1.88m ² /panel	black 12 mm 1900 g/m ²	X	NRC ≈ 0.92

WOOD SLATE SET CONJUNTOS DE RIPADO DE MADEIRA

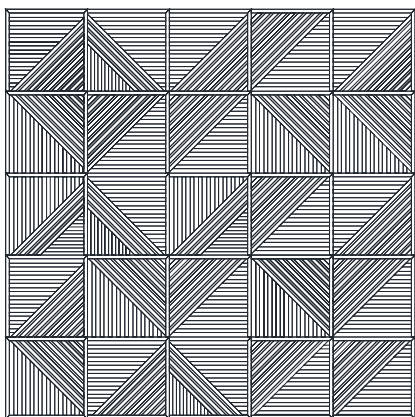

TRAMA

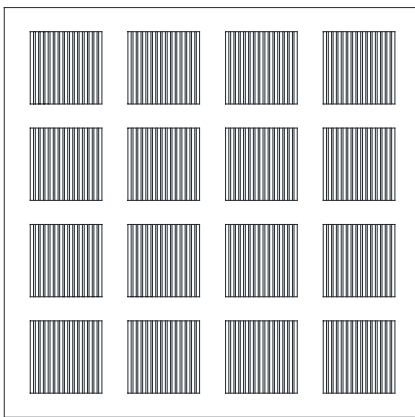

GRID

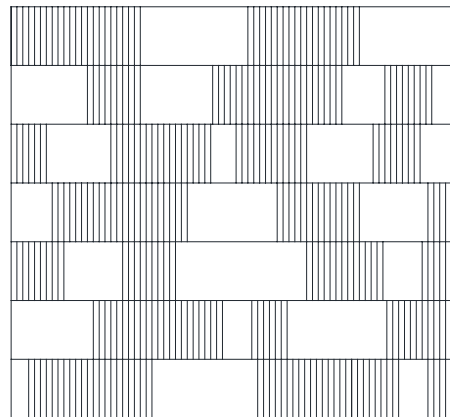

MATRIX



GRID



FLOW 1

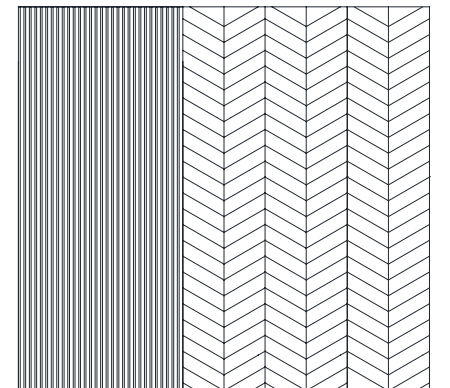

COMBO 1

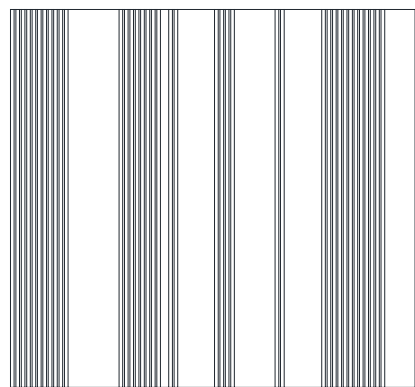

FLOW 2

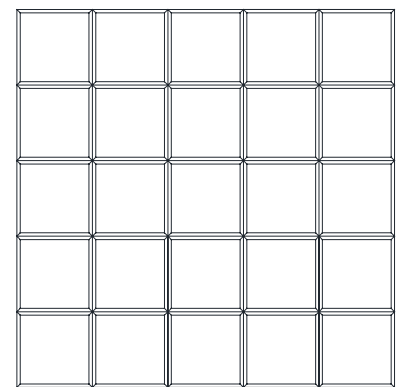

FRAME 1

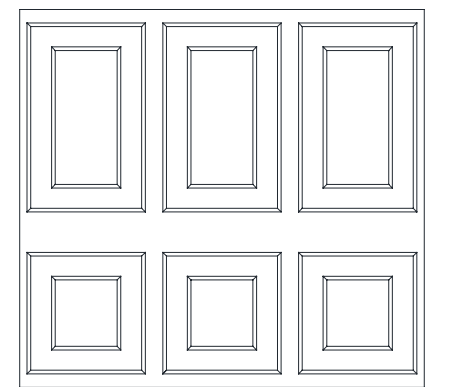

DISPLAY

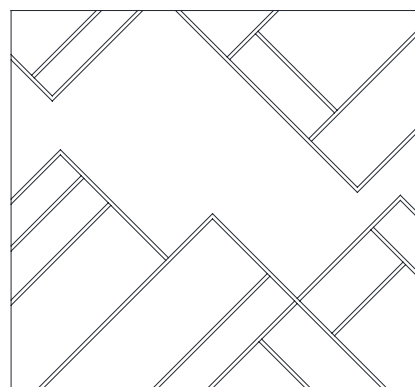

OBLIQUE 1

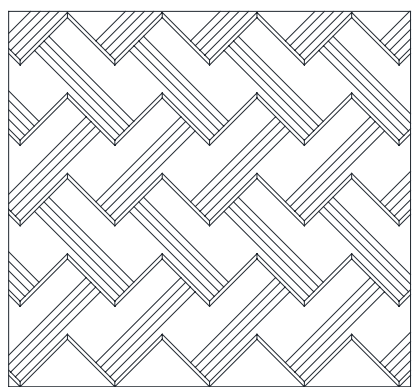

OBLIQUE 2

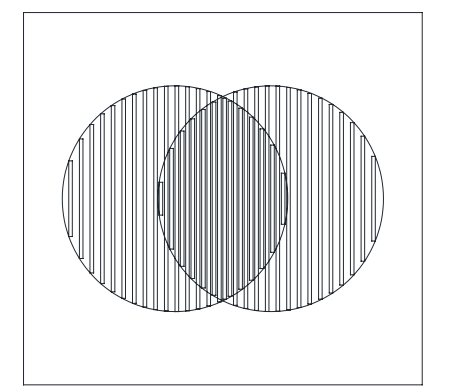

ORBIT



WOOD SLATE SET CONJUNTOS DE RIPADO DE MADEIRA

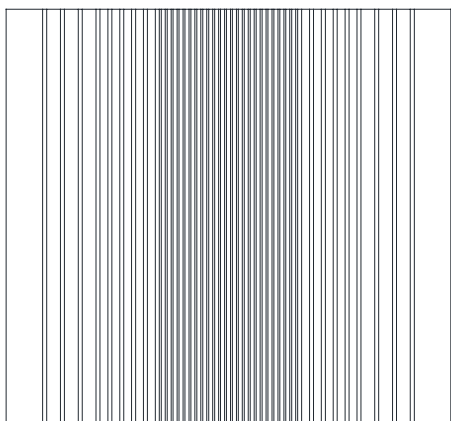

FLOW 3

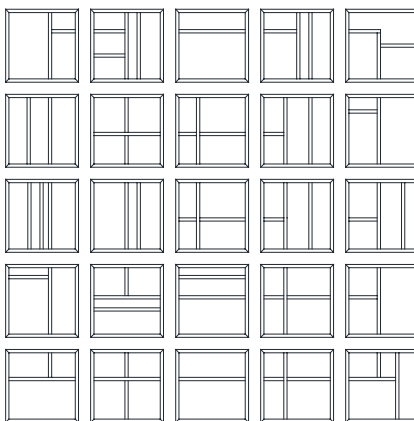

FRAME 2

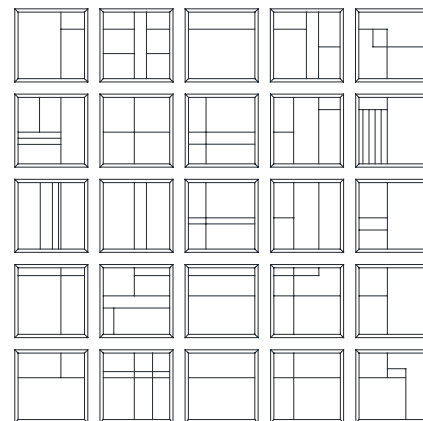

FRAME 3

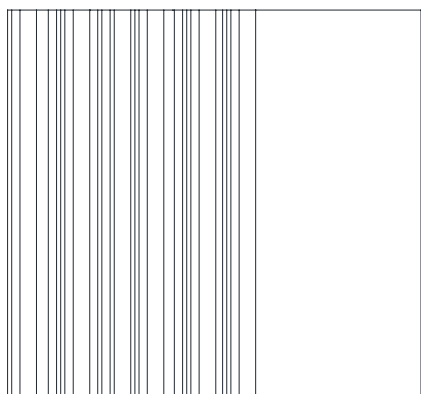

FLOW 3

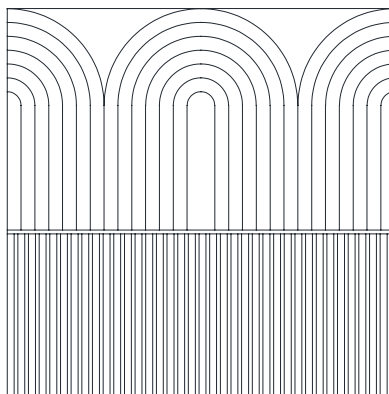

COMBO 2

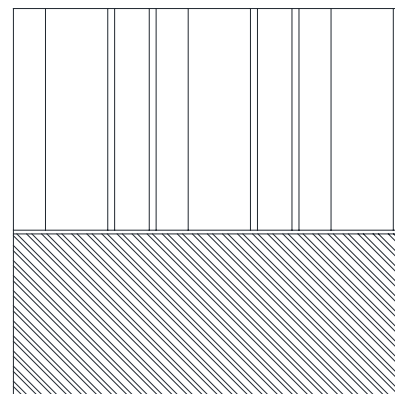

COMBO 3

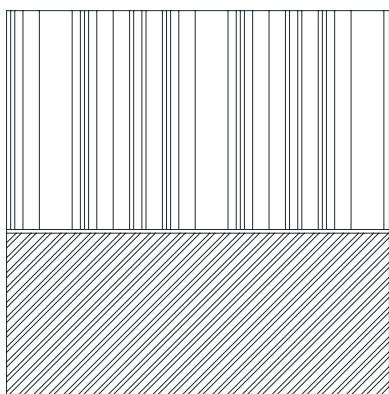

COMBO 4

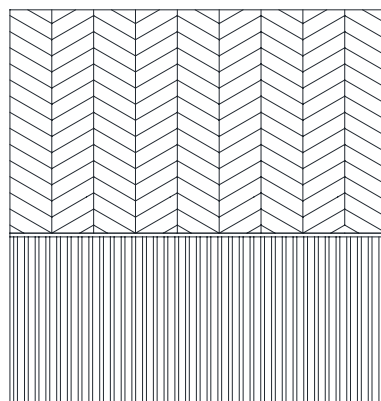

COMBO 5

COLOURS

CORES



The colours available for each thickness are listed in the table on the next page.
Cores disponíveis em cada espessura especificadas na tabela da página seguinte.



TECHNICAL DATA

INFORMAÇÃO TÉCNICA

MAIN FEATURES

CARACTERÍSTICAS PRINCIPAIS

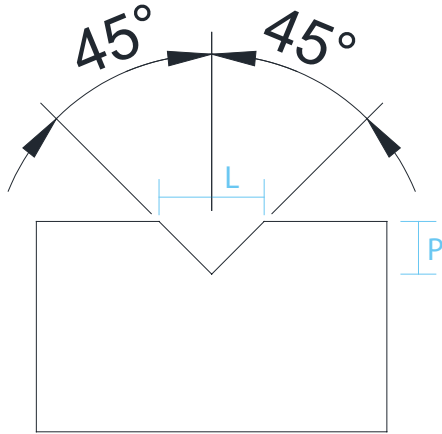

Bisel 45°

L	P
3 mm	1.5 mm
6 mm	3 mm
9 mm	4.5 mm
12 mm	6 mm

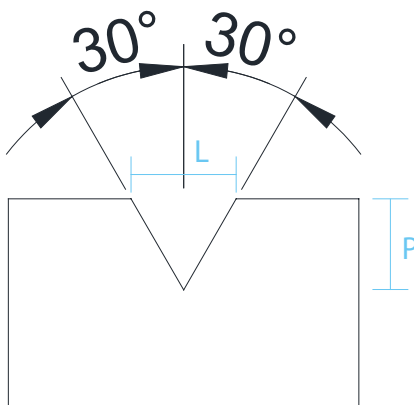

Bisel 30°

L	P
3 mm	2.59 mm
6 mm	5.19 mm
9 mm	7.79 mm
12 mm	10.39 mm

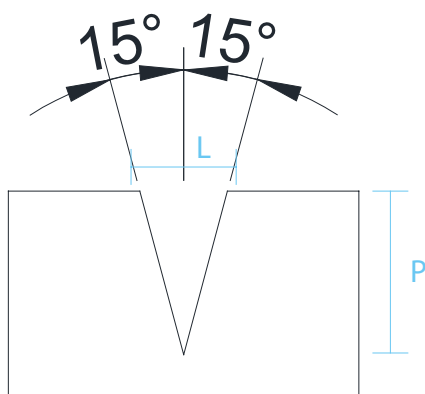

Bisel 15°

L	P
3 mm	5.9mm
5 mm	9.33 mm

NOTE: BEVEL WIDTH (W) AND DEPTH (D) ARE ADJUSTABLE WITHIN THE MATERIAL'S LIMITS.
 NOTA: LARGURA (L) E PROFUNDIDADE (P) DO BISEL AJUSTÁVEL DENTRO DO LIMITE DO MATERIAL

TECHNICAL DATA

INFORMAÇÃO TÉCNICA

CERTIFICATIONS PET

CERTIFICAÇÕES PET



EN 13501 CLASS B-s1,d0
ASTM E84 CLASS A



EXEMPLARY LEVEL EMISSION
CRITERIA OF BREEAM



ISO 116554: $\alpha W=0.25$ | ISO 354



EC1^{PLUS} CLASSIFICATION
BY EMICODE CRITERIA



OEKO-TEX®
STANDARD 100 20230K1743



MEETS FORMALDEHYDE
LIMIT REQUIRED BY LEED



IMO MSC.307 (88)
ANNEX 1 PART 5



AUSÊNCIA DE AZO-
COMPOSTOS, FTALATOS
E DMF



ASTM E2149



ISO 846



EN ISO 105 B-02: 6-7



EN ISO 105-X12: 4-5

CERTIFICATIONS WOOD

CERTIFICAÇÕES WOOD



ASTM E84 CLASS A
EN 13501 CLASS B-s3,d0



NRC = 0.72* (ISO 354:2003)



OEKO-TEX® STANDARD 100
(testado para substâncias nocivas)



FSC® Chain of Custody Certificate
(AEN-COC-001396)

Material certificado segundo a norma BS EN 13964:2014 (Suspended Ceilings. Requirements and Test Methods).



TECHNICAL DATA

INFORMAÇÃO TÉCNICA

MAIN FEATURES

CARACTERÍSTICAS PRINCIPAIS



**RECYCLED FROM
PET BOTTLES**
RECICLADO A PARTIR DE
GARRAFAS PET



CHEMICALLY STABLE
QUIMICAMENTE INERTE



ACOUSTIC INSULATOR
ISOLANTE ACÚSTICO



THERMIC INSULATOR
ISOLANTE TÉRMICO



EASY TO HANDLE
FÁCIL MANUSEAMENTO



ODOULESS
INODORO



FIRE PROOF
INGÍFUGO



IMPACT RESISTANT
RESISTENTE AO CHOQUE



MOLD RESISTANT
ANTIFÚNGICO



LONG LASTING
DURÁVEL



ANTI-BACTERIAL
ANTIBACTERIANO



**FREE OF HARMFULL
CHEMICALS**
LIVRE DE PRODUTOS
QUÍMICOS NOCIVOS



ANTI-STAIN
ANTI-MANCHA



ANTI-STATIC
ANTIESTÁTICO



WATER PROOF
ATI-MANCHA



EASY TO CLEAN
FÁCIL DE LEIMPAR

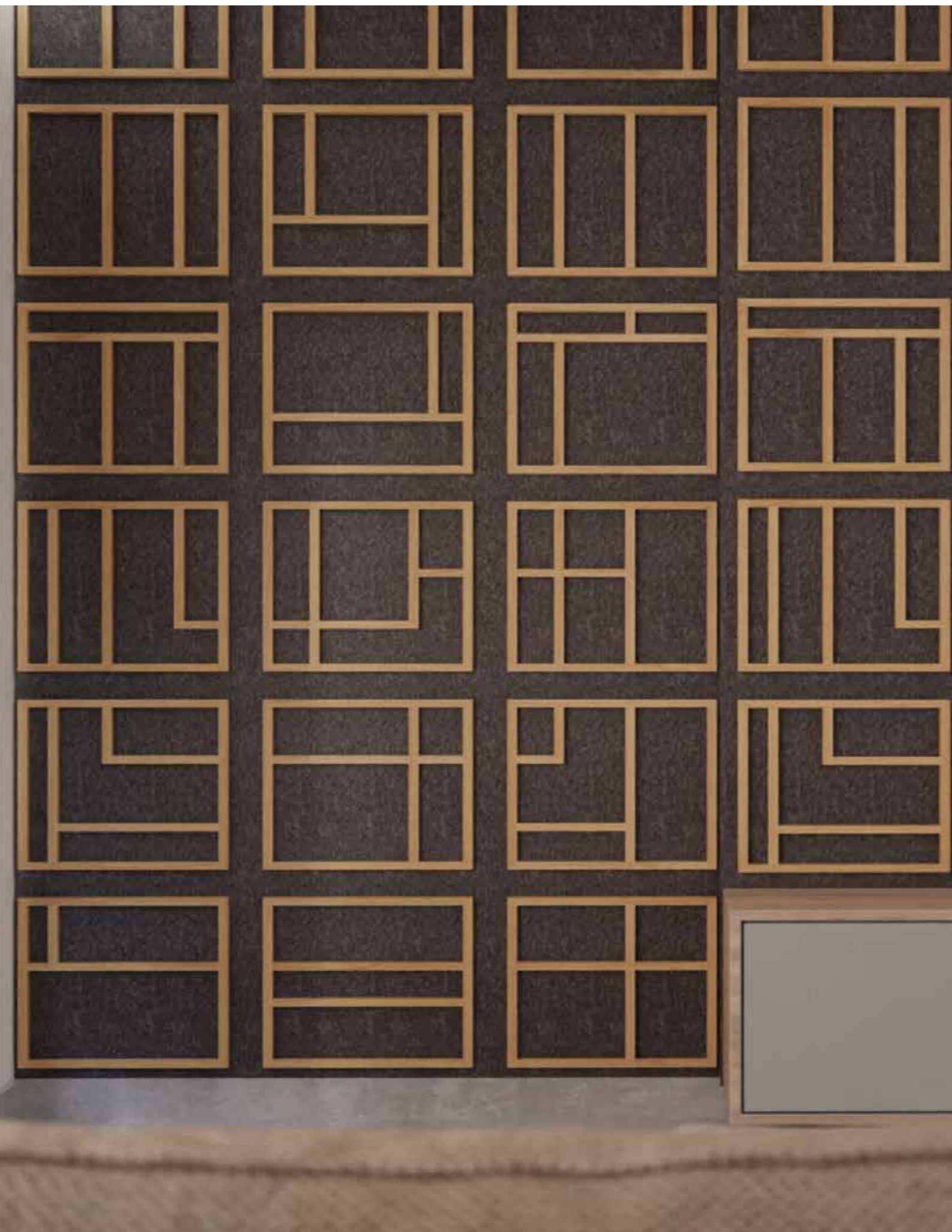

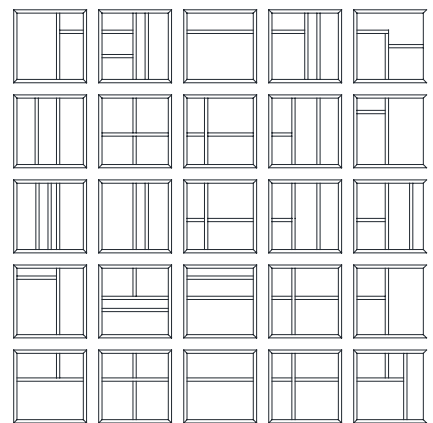

FRAME 2

Contacts | Contactos

T.: +351 234 622 114

Custo de chamada para rede fixa nacional.

comercial@carlosnatal.pt

www.carlosnatal.pt

Parque Empresarial do Casarão

Avenida das Ferragens, 87

3750-860 Águeda, Portugal

Follow us | Siga-nos nas redes sociais

Instagram · LinkedIn · Youtube

© 2025 Carlos Natal, Lda. All rights reserved.
