

# W O O D & P E T

ACOUSTIC PANELS  
WOOD & PET  
CATALOGUE



carlos natal®  
feeling beyond quality



**Aesthetics,  
acoustics, balance.**

**Estética,  
acústica, equilíbrio.**



## SLATTED PANEL IN NATURAL WOOD

The perfect combination of the acoustic performance of pet panels and the natural, organic look of wood. A versatile solution that adapts to any space, allowing you to create environments full of comfort and sophistication.

## PAINEL RIPADO DE MADEIRA NATURAL

A combinação perfeita entre a performance acústica das placas PET e o aspecto natural e orgânico da madeira. Uma solução adaptável a qualquer espaço e que permite criar ambientes repletos de conforto e sofisticação.

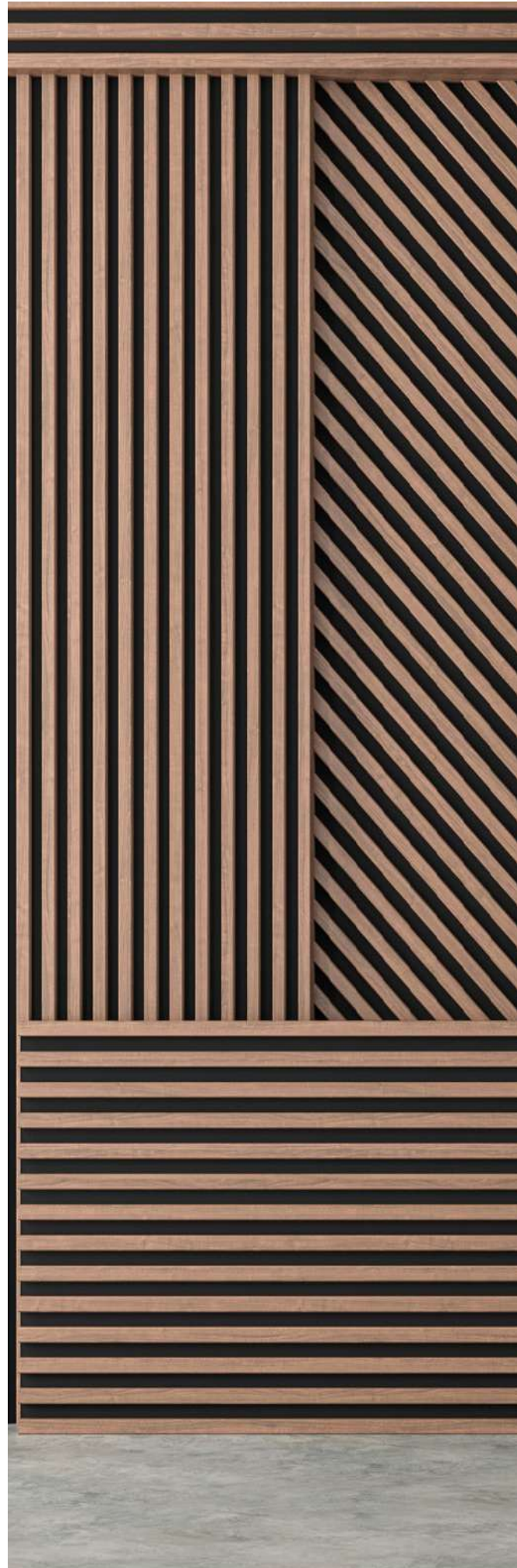

**FORESTS  
FOR ALL  
FOREVER**

**STANDARD  
100**

20230K1743  
AITEX

[WWW.OEKO-TEX.COM](http://WWW.OEKO-TEX.COM)







## COMPOSITION COMPOSIÇÃO

### **100% poliéster PET (60% fibra PET reciclada + 40% fibra PET virgem) 9mm**

A base em PET do painel vai absorver e provocar a dispersão das ondas sonoras

### **MDF de baixa densidade**

O formato ripado do MDF actua como difusor do ruído

### **Folha de madeira natural**

Através da utilização de madeira verdadeira como matéria-prima, e recorrendo à tecnologia de biónica e desenho 3D, foi possível desenvolver um novo conceito de painel acústico decorativo.



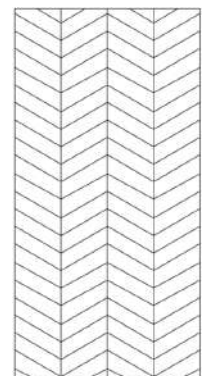

FISHBONE 1\*

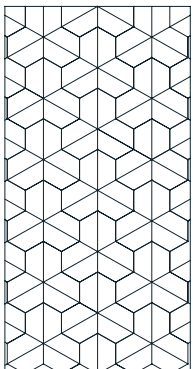
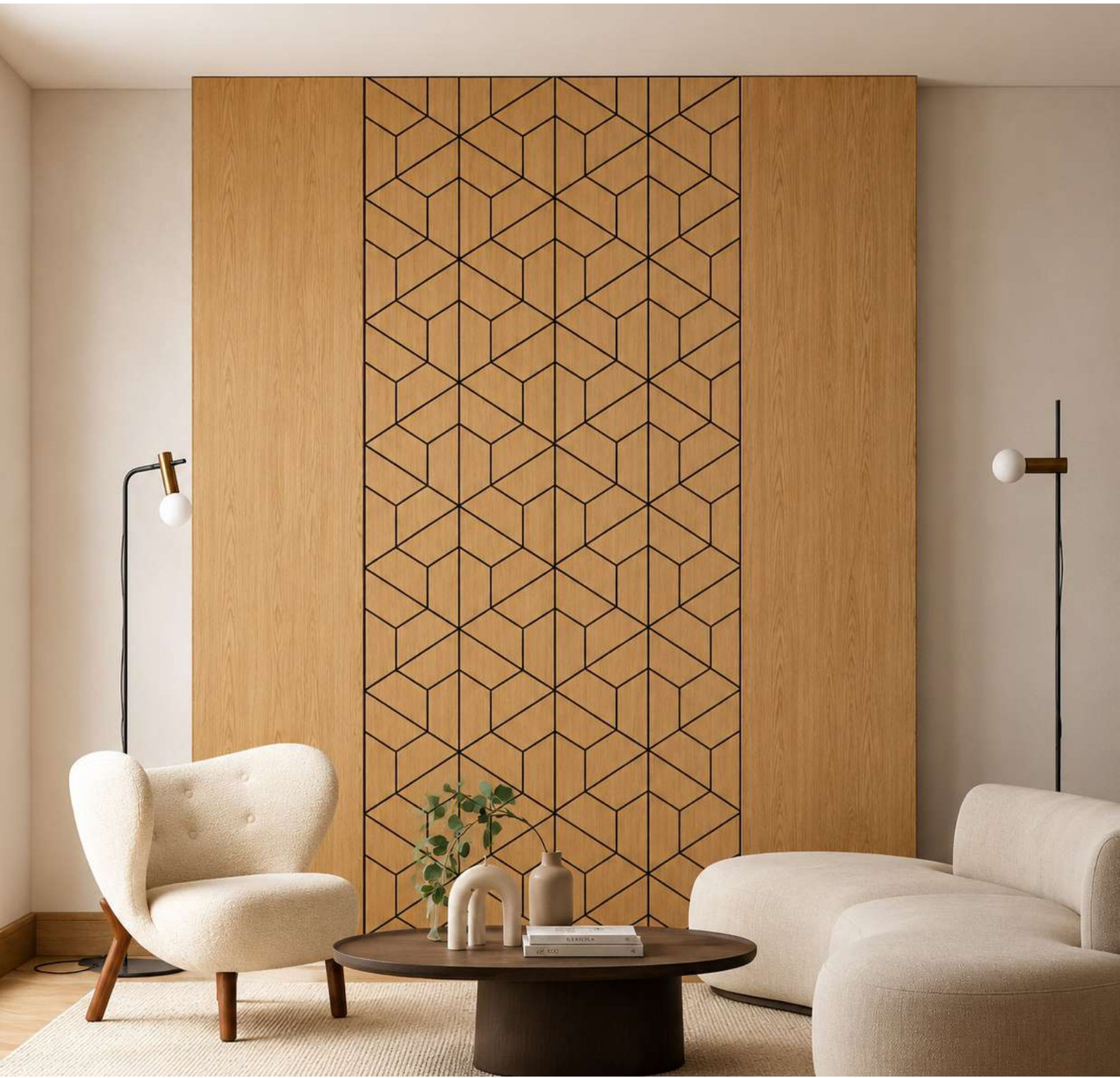

CLOVER\*



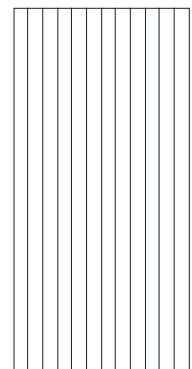

STRIPES 1\*



A photograph of a pool table in a lounge. The wall behind the table is a deep red color with a gold-colored geometric pattern of intersecting lines. Two black pendant lamps hang above the table. To the right, there is a bar area with shelves of bottles and a marble countertop. In the foreground, there are brown leather chairs and a round table with some items on it. The overall atmosphere is warm and sophisticated.

Where comfort  
meets nature.

Onde o conforto  
encontra a natureza.

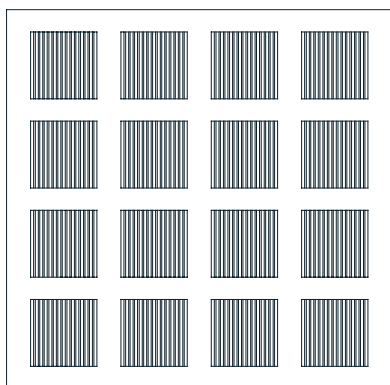

GRID



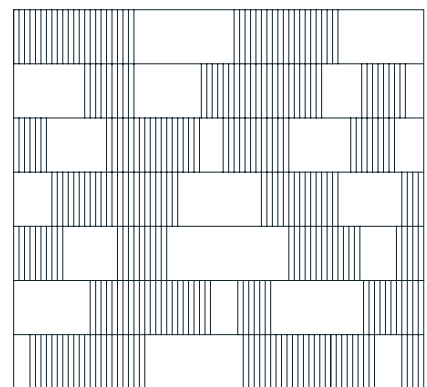

MATRIX

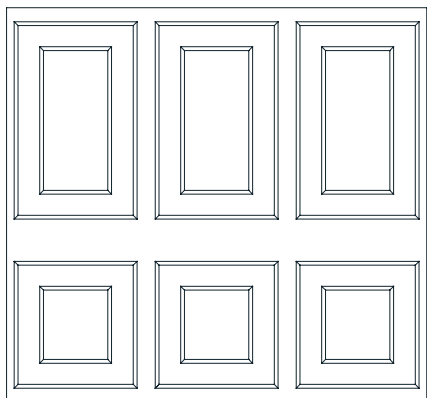

DISPLAY



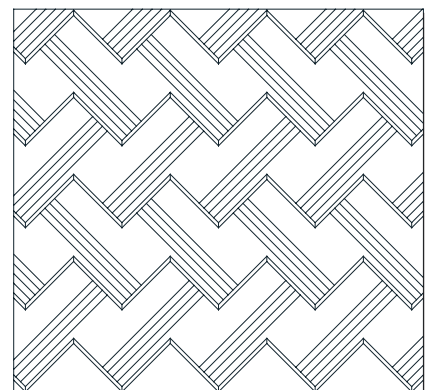

OBLIQUE 2

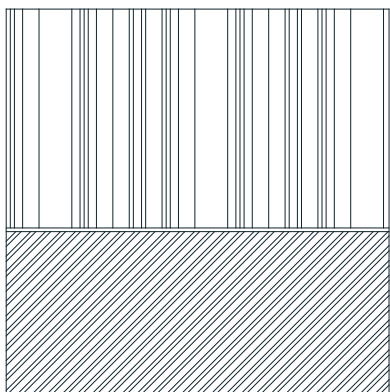
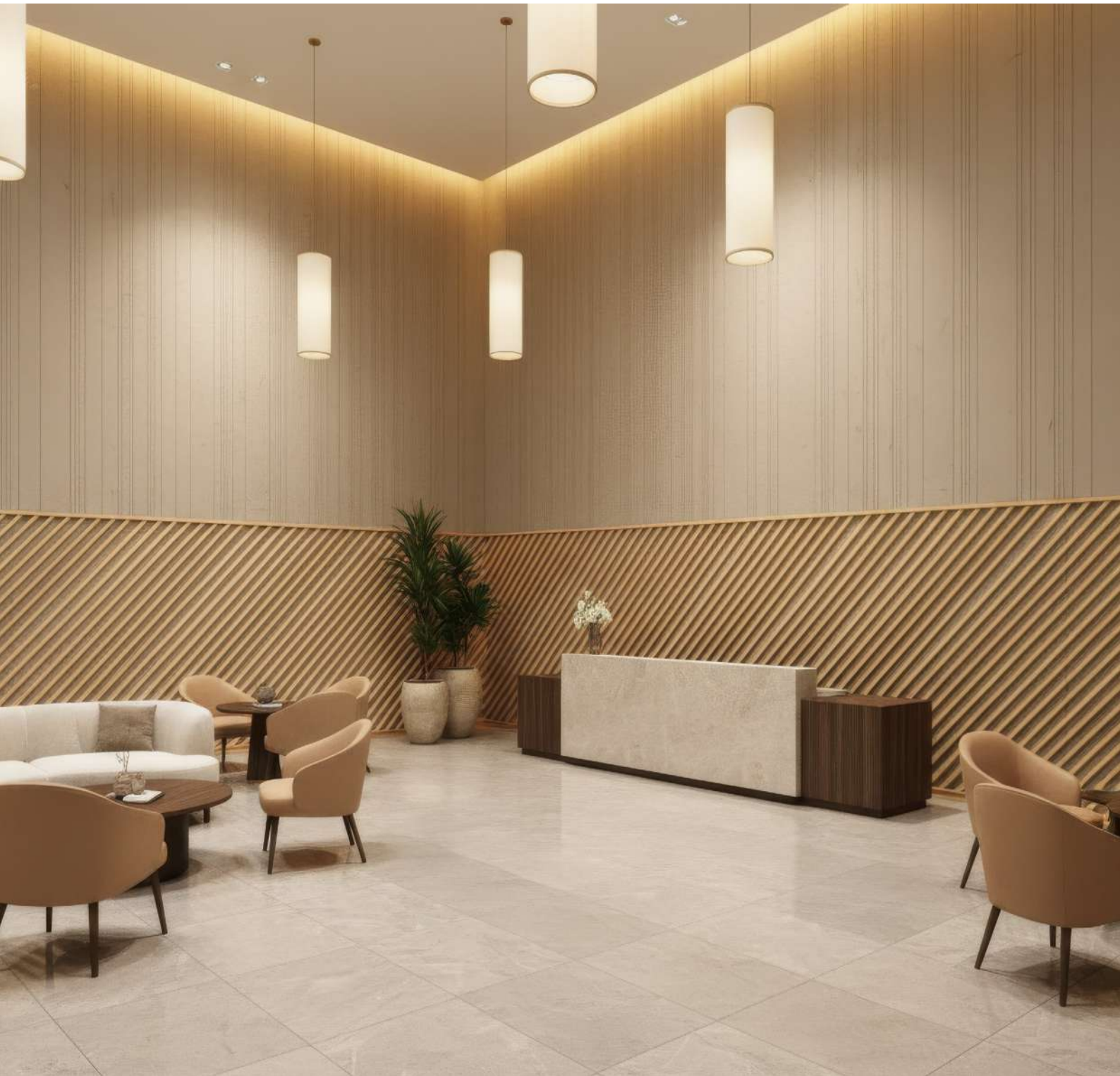

COMBO 4



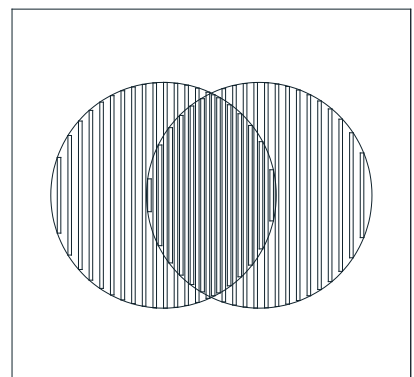

ORBIT

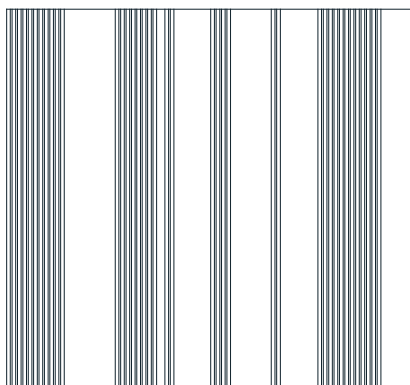

FLOW 2



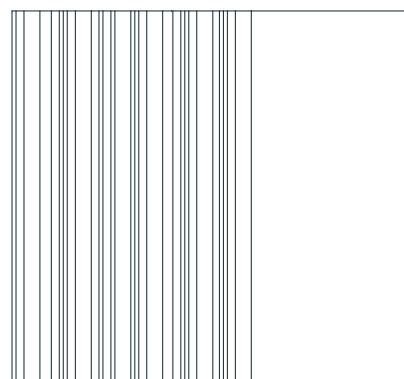
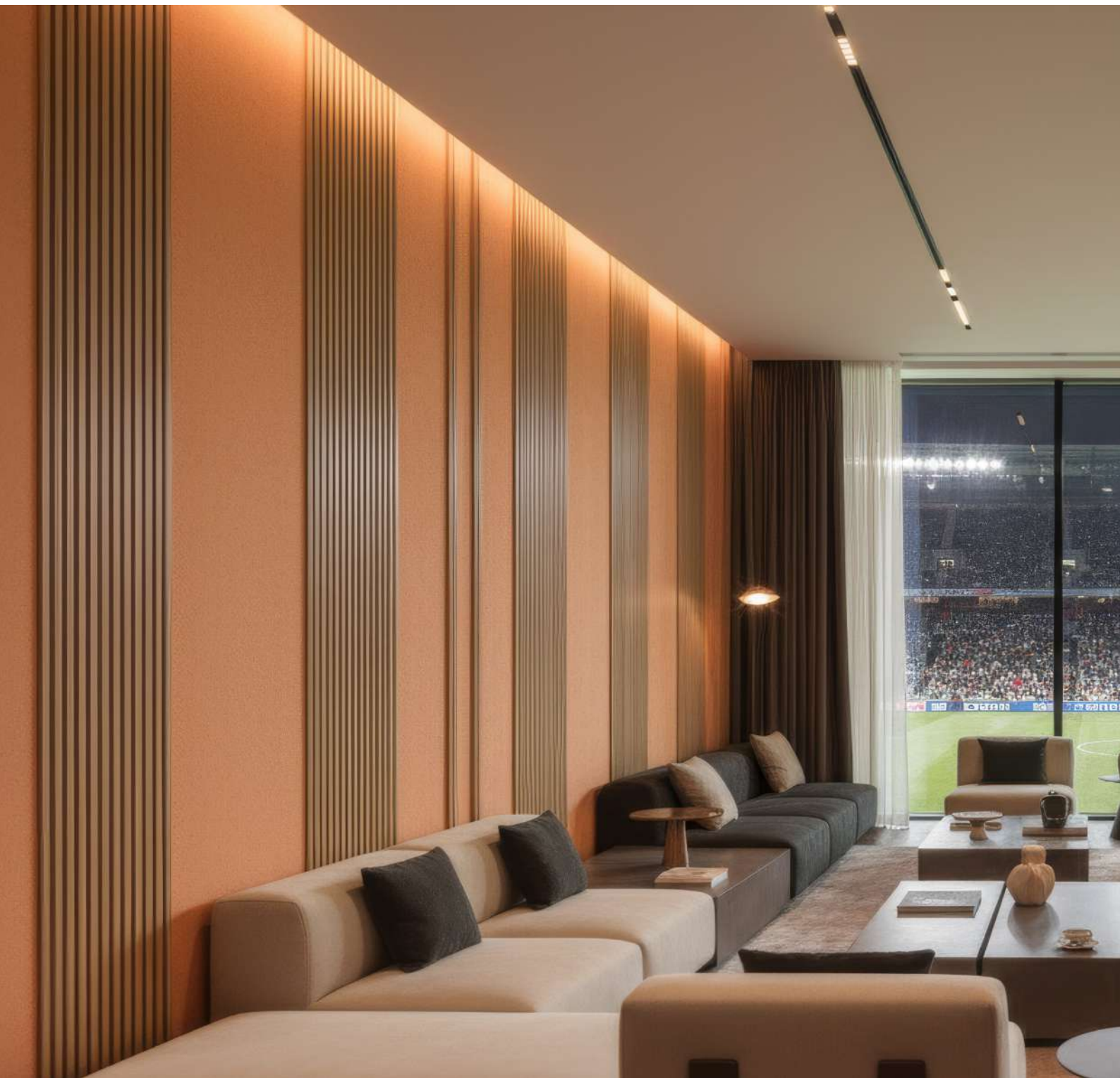

FLOW 4

FLOW 4

# SLAT COLOURS

## CORES DO RIPADO

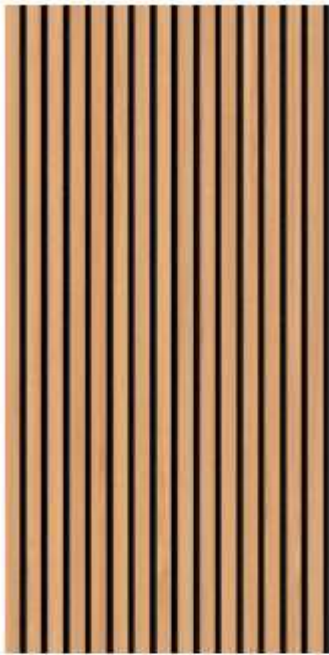

Faia

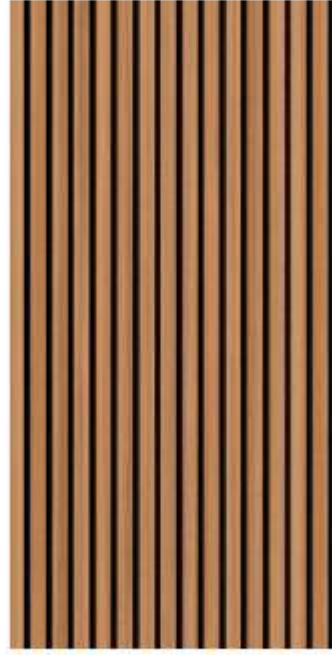

Alvarinho



Nogueira



Wengue



# STANDARD PANELS PAINÉIS STANDARD

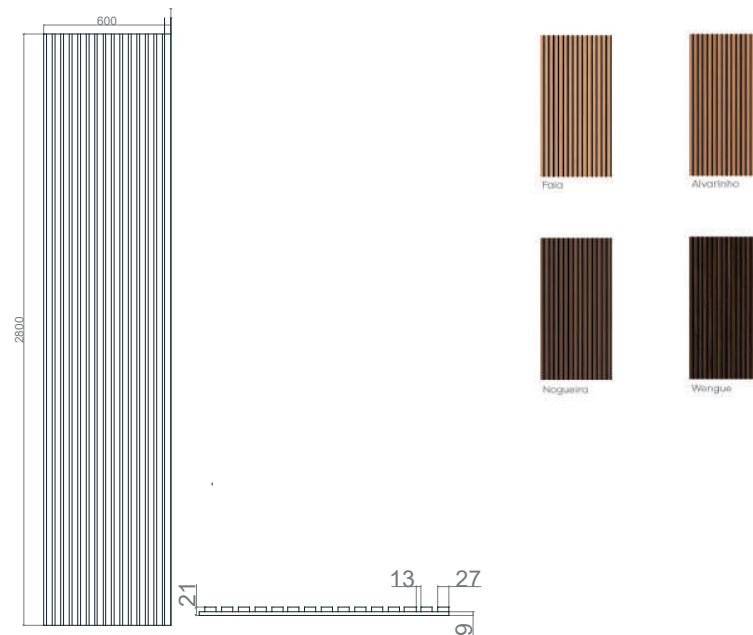

Ripas folheadas nas 3 faces para máxima semelhança com madeira maciça

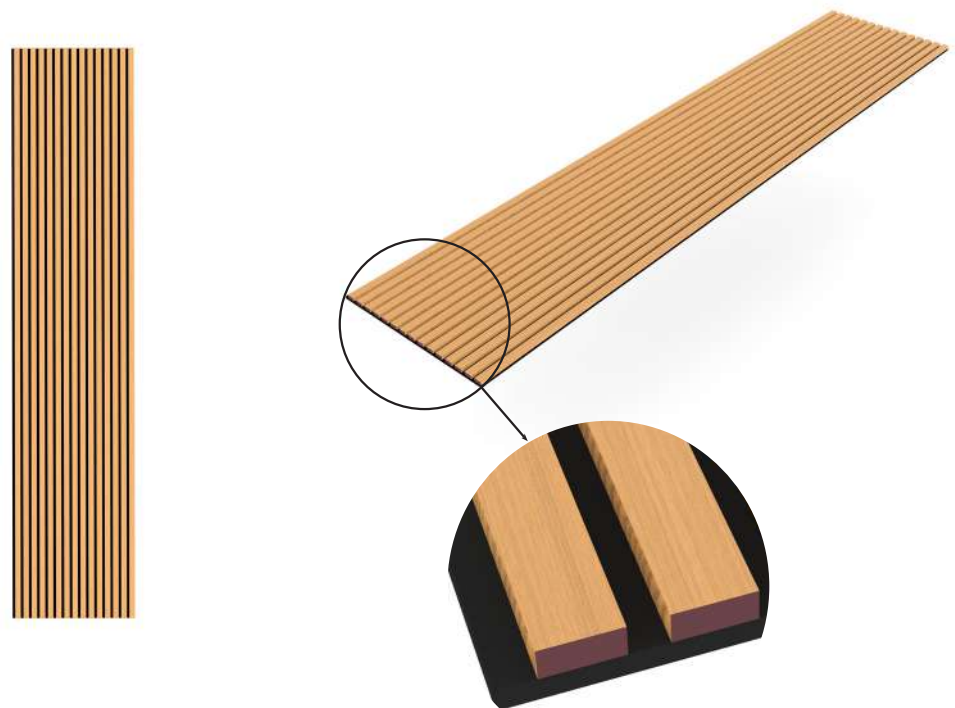

	Ref	Composition	Panel Dimensions	PET Specs	Fire Resistance	Acoustic Performance
Ripado de Madeira FR Folheado 3 Faces (PET Preto)	614	Wood wrapped MDF slats + PET panel	2800 * 600 * 21 mm 168m <sup>2</sup> /panel	black 9 mm 1300 g/m <sup>2</sup>	EN 13501 B-s3-d0	NRC ≈ 0.80

# STANDARD PANELS PAINÉIS STANDARD

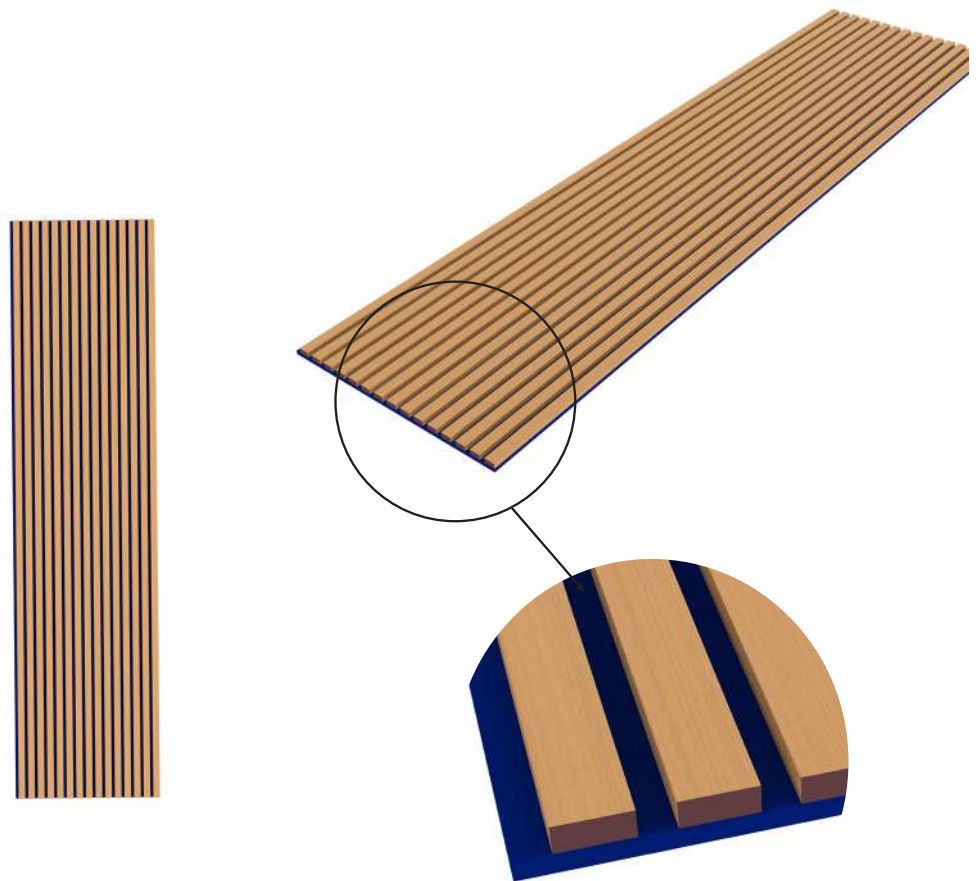
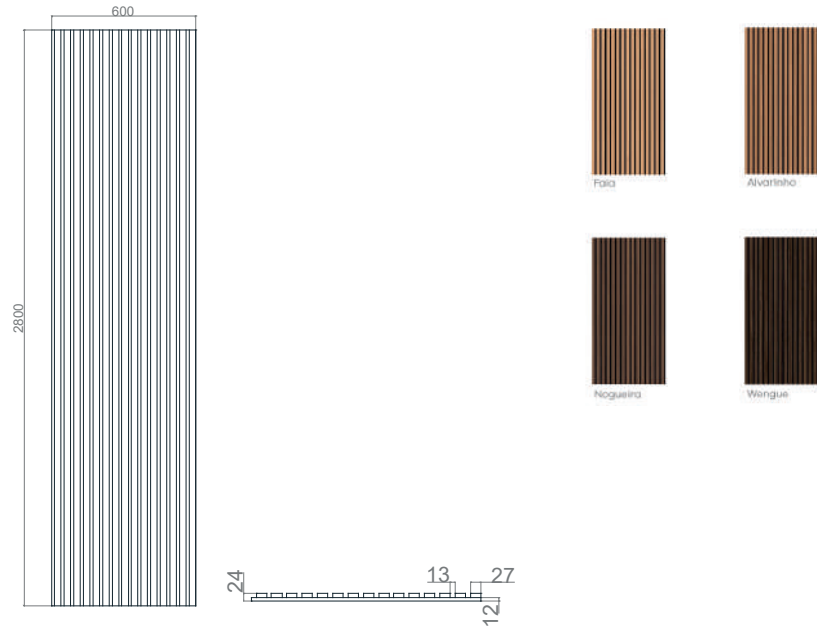

	Ref	Composition	Panel Dimensions	PET Specs	Fire Resistance	Acoustic Performance
Ripado de Madeira FR Folheado 3 Faces (PET Cores)	619	Wood wrapped MDF slats + PET panel	2400 * 600 * 24 mm 144m2/panel	33 colours 12 mm 2400 g/m2	EN 13501 B-s3-d0	NRC ≈ 0.80



# STANDARD PANELS PAINÉIS STANDARD

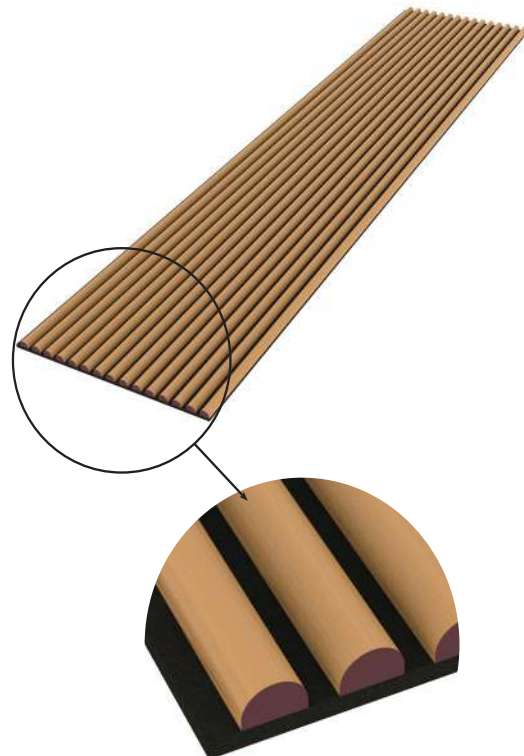
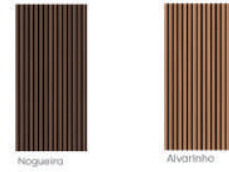
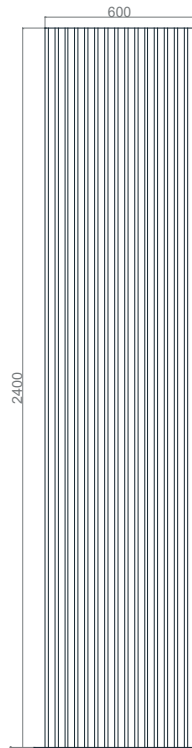

	Ref	Composition	Panel Dimensions	PET Specs	Fire Resistance	Acoustic Performance
Ripado de Madeira FR 1/2 cana (PET Preto)	615	Wood wrapped round MDF slats + PET panel	2800 * 600 * 24 mm 168m <sup>2</sup> /panel	black 9 mm 1300 g/m <sup>2</sup>	EN 13501 B-s3-d0	NRC ≈ 0.80

# STANDARD PANELS PAINÉIS STANDARD

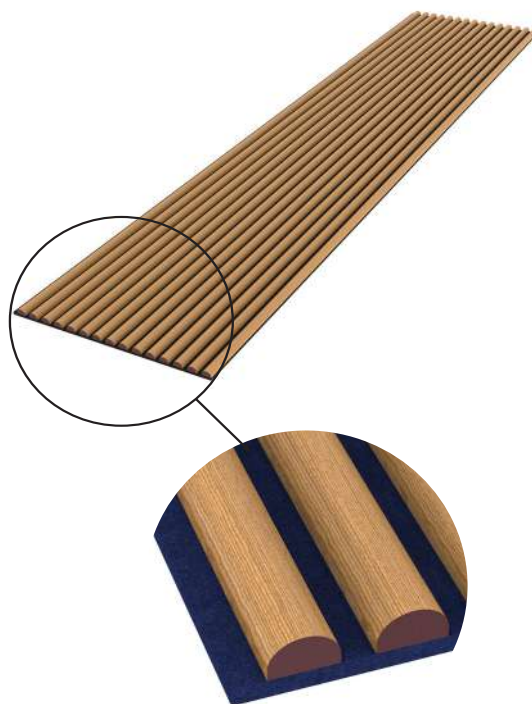
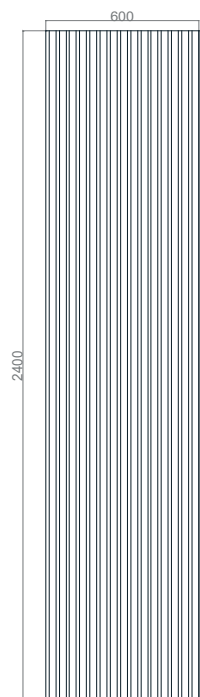

	Ref	Composition	Panel Dimensions	PET Specs	Fire Resistance	Acoustic Performance
Ripado de Madeira FR 1/2 Cana (PET Cores)	620	Wood wrapped round MDF slats + PET panel	2400 * 600 * 27 mm 1.44m <sup>2</sup> /panel	33 colours 12 mm 2400 g/m <sup>2</sup>	EN 13501 B-s3-d0	NRC ≈ 0.80



# STANDARD PANELS PAINÉIS STANDARD

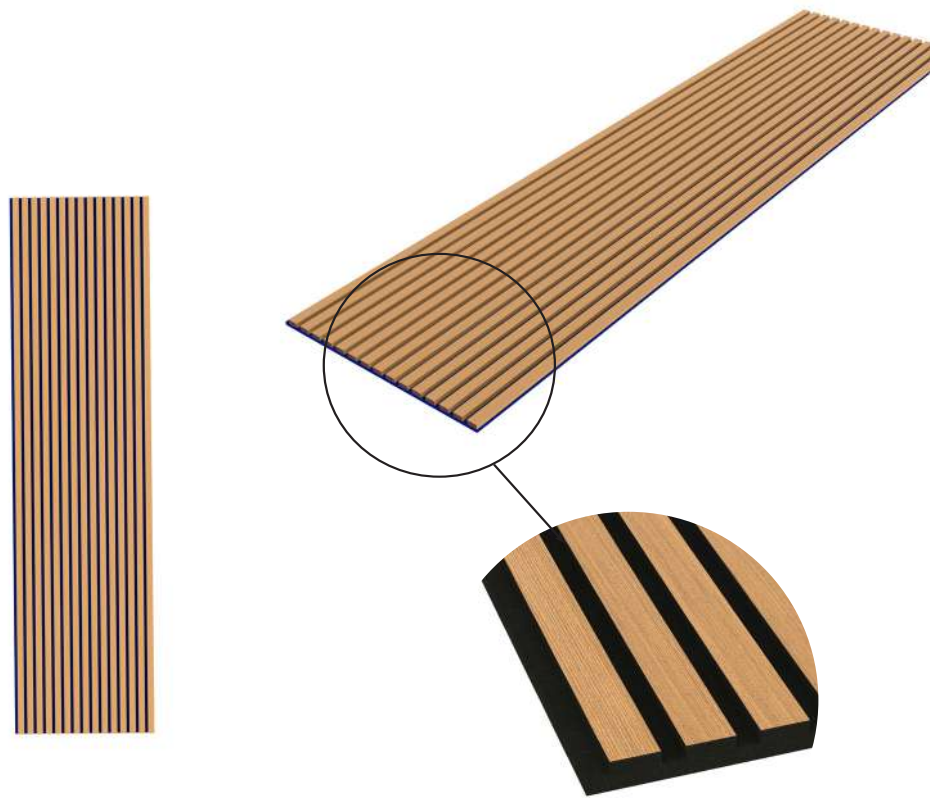
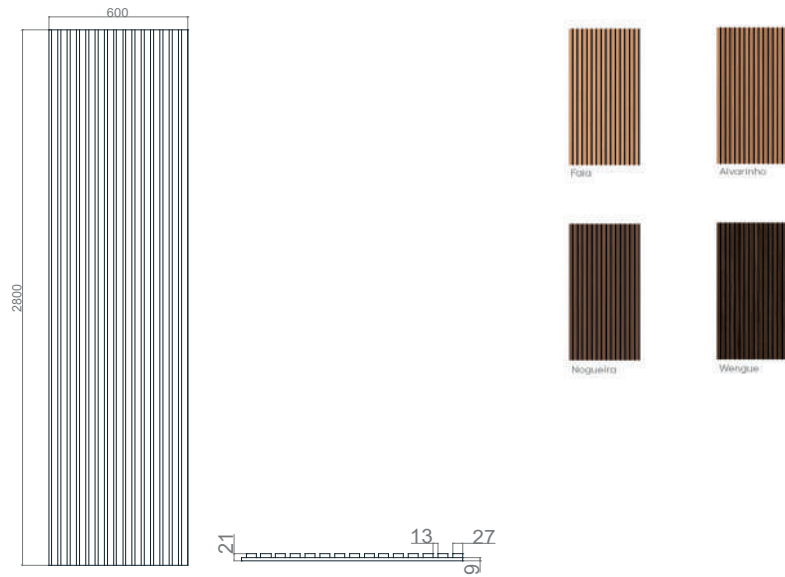

	Ref	Composition	Panel Dimensions	PET Specs	Fire Resistance	Acoustic Performance
Ripado de Madeira Folheado 1 Face (PET Preto)	618	Wood laminated MDF slats + PET panel	2800 * 600 * 21 mm 1.68m <sup>2</sup> /panel	black 9 mm 1300 g/m <sup>2</sup>	x	NRC ≈ 0.80

# STANDARD PANELS PAINÉIS STANDARD

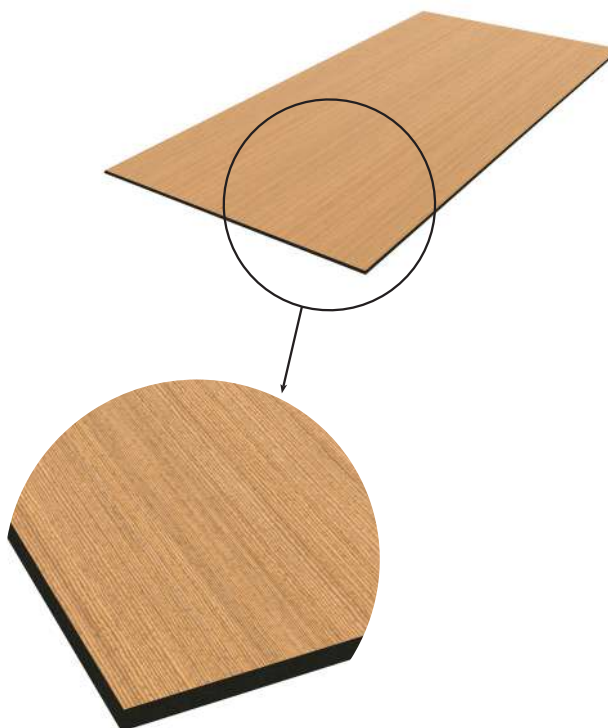

	Ref	Composition	Panel Dimensions	PET Specs	Fire Resistance	Acoustic Performance
Folheado de Madeira 1 Face (PET Preto)	616	Wood veneer + PET panel	2440 * 1220 * 12 mm 2.98m2/panel	black 12 mm 1900 g/m2	X	NRC ≈ 0.55



# STANDARD PANELS PAINÉIS STANDARD

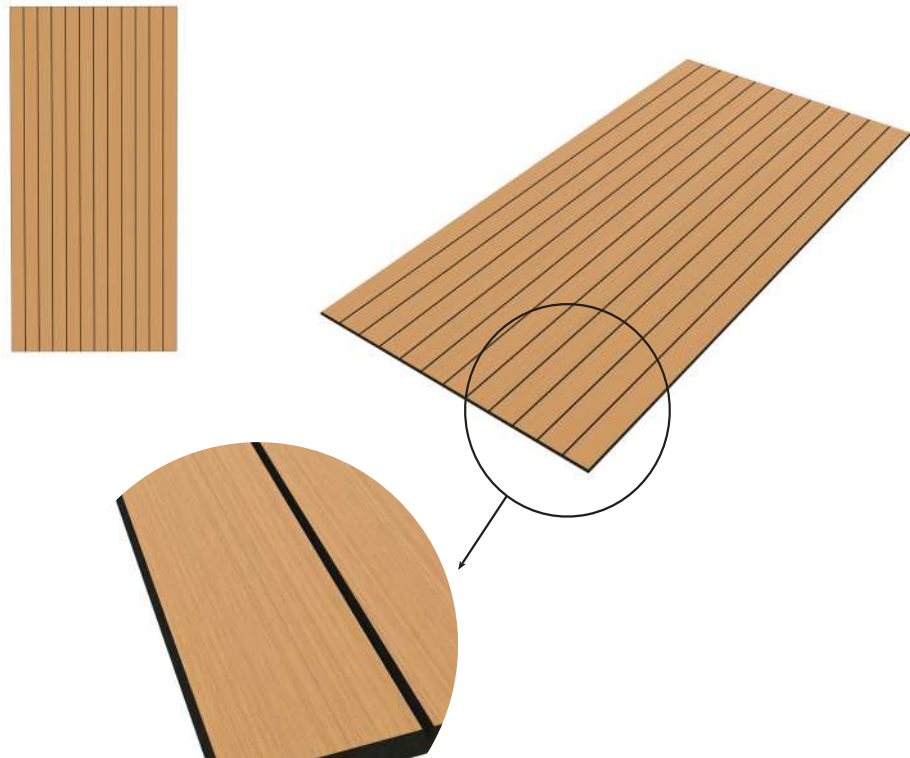
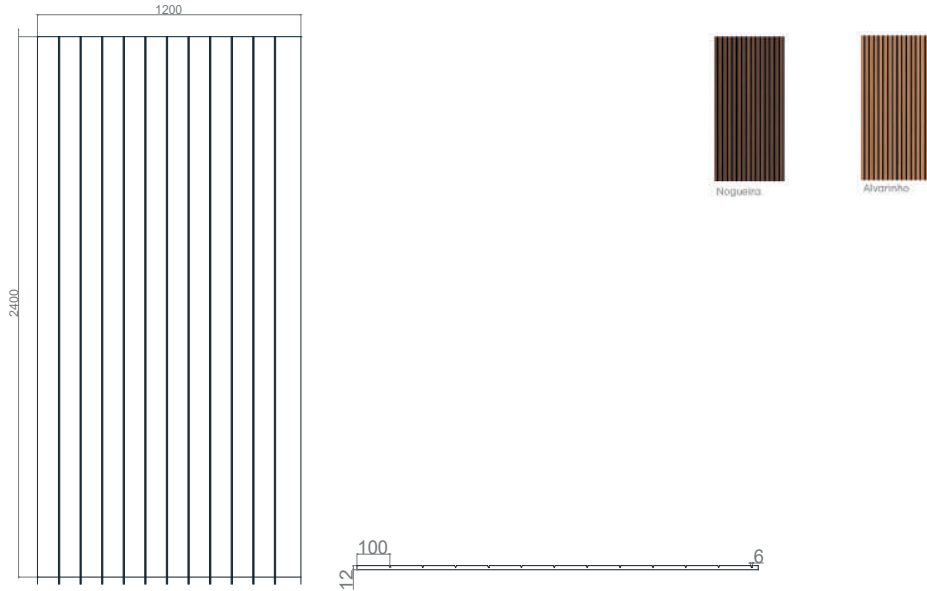

	Ref	Composition	Panel Dimensions	PET Specs	Fire Resistance	Acoustic Performance
Folheado Madeira Bisel 30°/30° mm (PET Preto)	621	Wood veneer + PET panel	2400 * 1200 * 12 mm 1.88m <sup>2</sup> /panel	black 12 mm 1900 g/m <sup>2</sup>	X	NRC ≈ 0.92

# WOOD SLATE SET

CONJUNTOS DE RIPADO DE MADEIRA

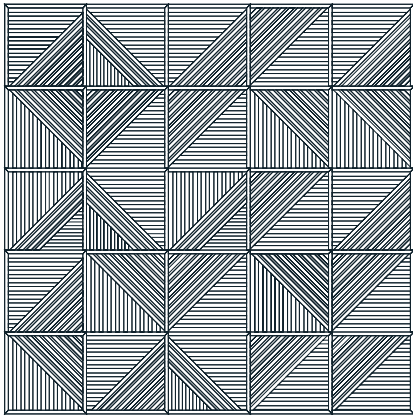

TRAMA

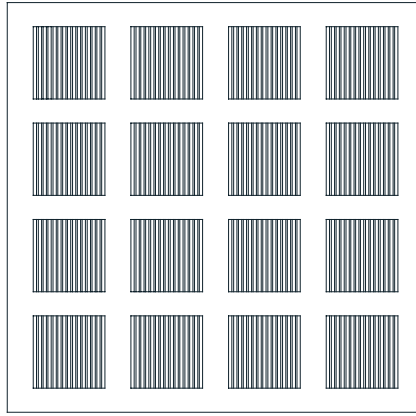

GRID

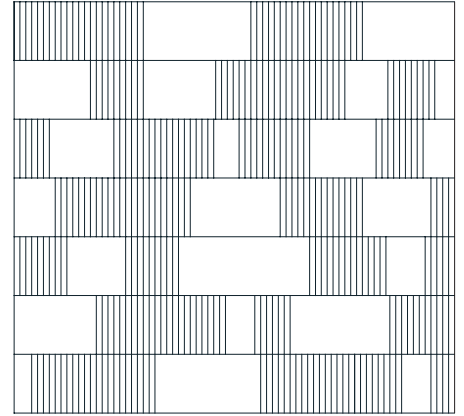

MATRIX

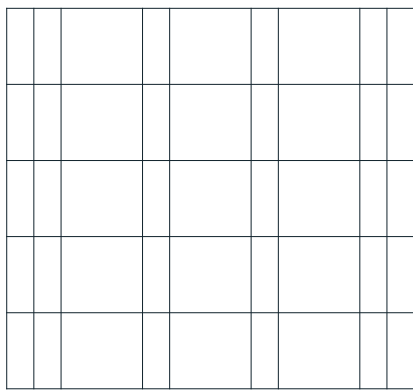

GRID

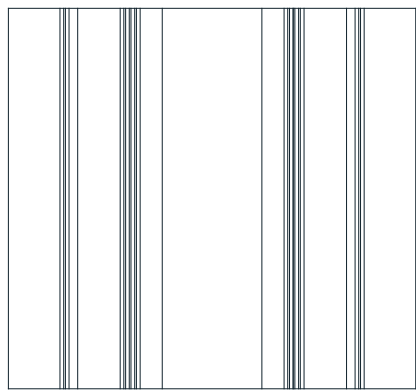

FLOW 1

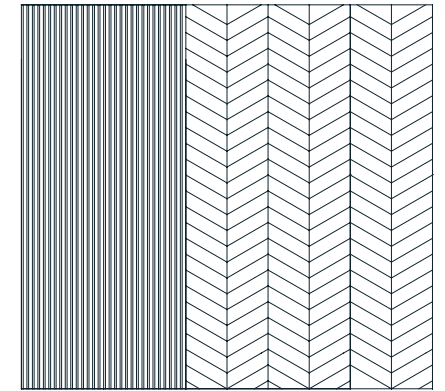

COMBO 1

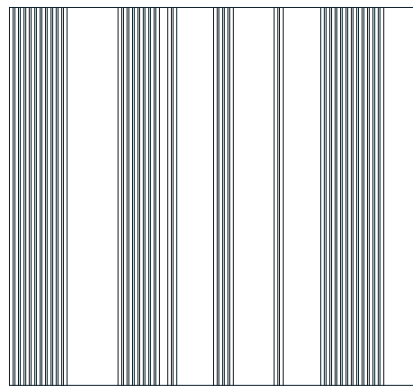

FLOW 2

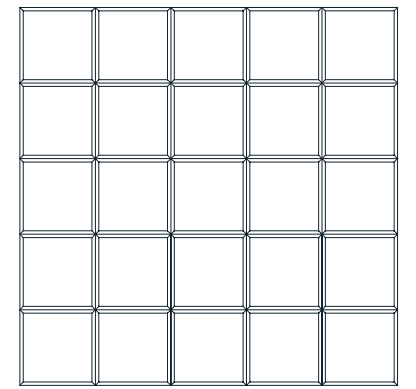

FRAME 1

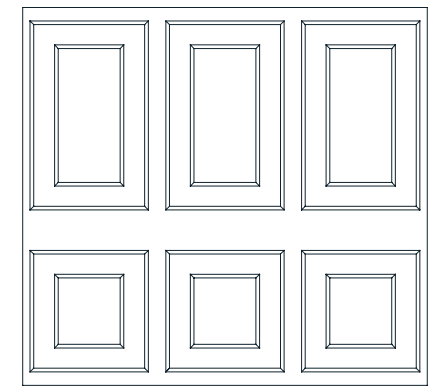

DISPLAY

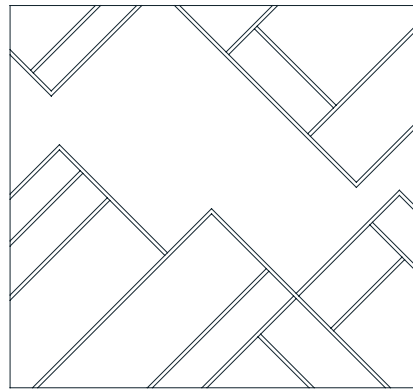

OBLIQUE 1

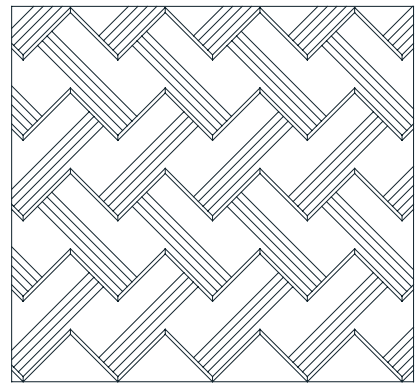

OBLIQUE 2

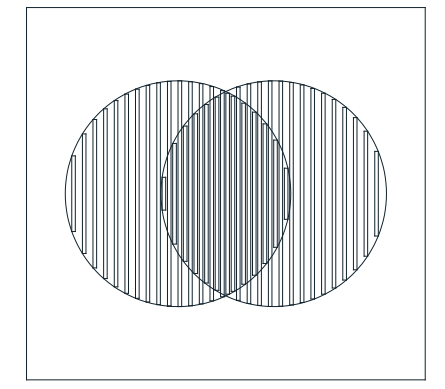

ORBIT



# WOOD SLATE SET

CONJUNTOS DE RIPADO DE MADEIRA

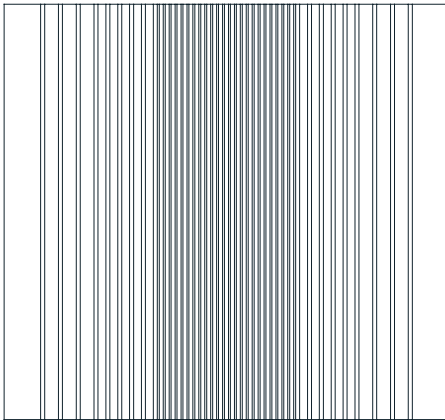

FLOW 3

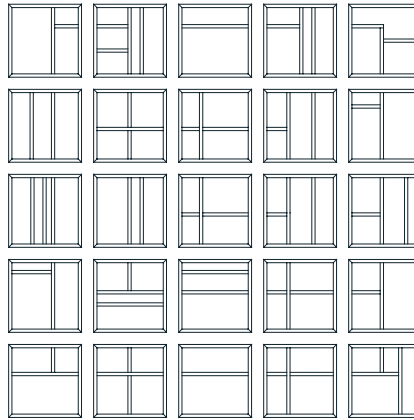

FRAME 2

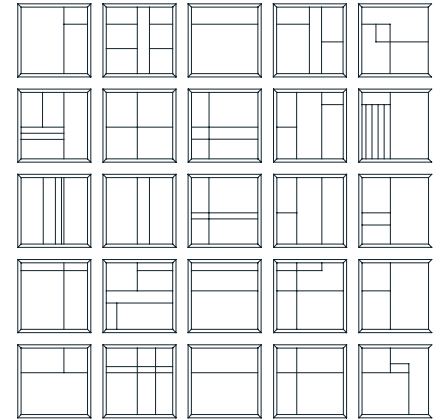

FRAME 3

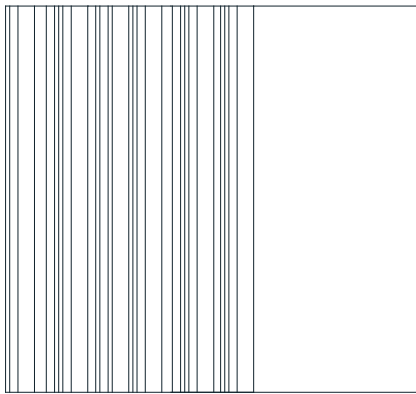

FLOW 4

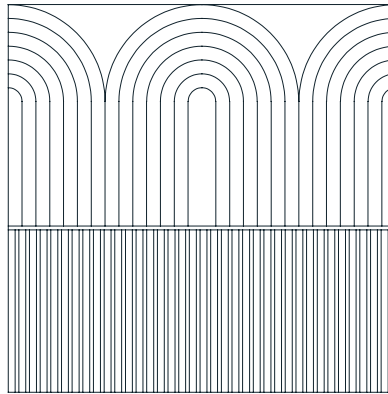

COMBO 2

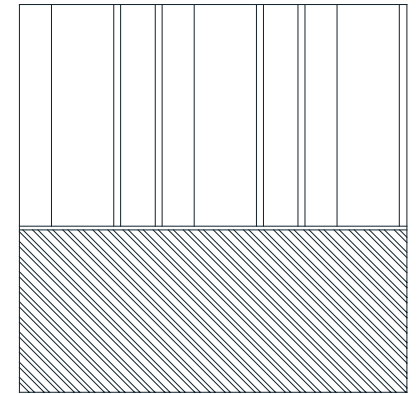

COMBO 3

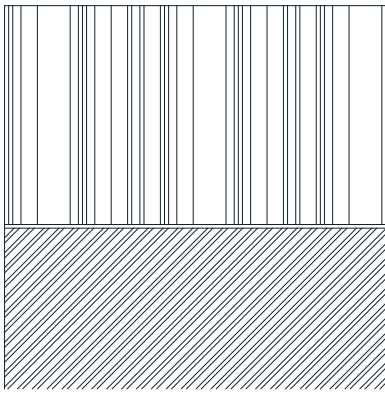

COMBO 4

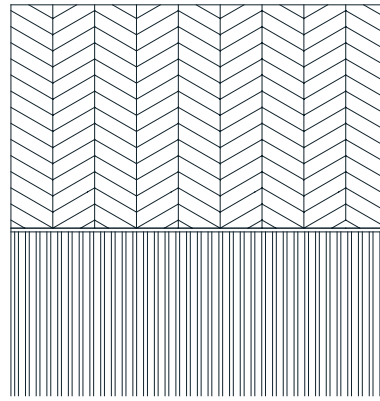

COMBO 5

# COLOURS

## CORES



# TECHNICAL DATA

## INFORMAÇÃO TÉCNICA

### MAIN FEATURES

### CARACTERÍSTICAS PRINCIPAIS

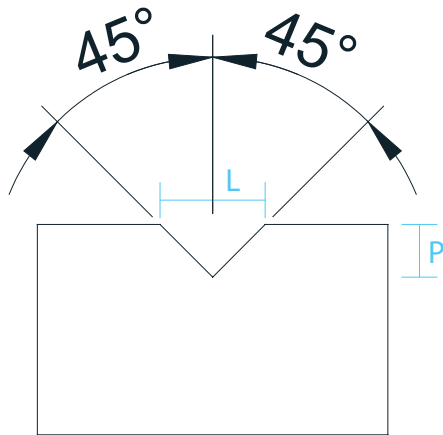

Bisel 45°

L	P
3 mm	1.5 mm
6 mm	3 mm
9 mm	4.5 mm
12 mm	6 mm

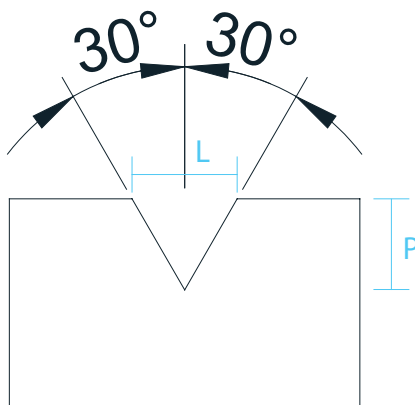

Bisel 30°

L	P
3 mm	2.59 mm
6 mm	5.19 mm
9 mm	7.79 mm
12 mm	10.39 mm

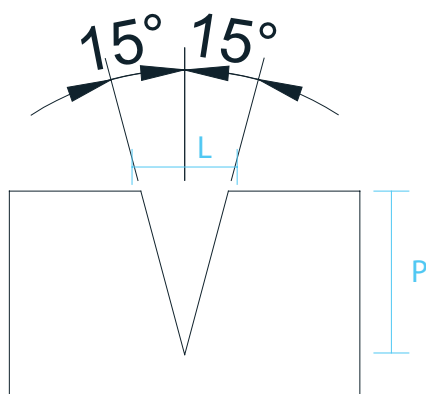

Bisel 15°

L	P
3 mm	5.9mm
5 mm	9.33 mm

NOTE: BEVEL WIDTH (W) AND DEPTH (D) ARE ADJUSTABLE WITHIN THE MATERIAL'S LIMITS.  
 NOTA: LARGURA (L) E PROFUNDIDADE (P) DO BISEL AJUSTÁVEL DENTRO DO LIMITE DO MATERIAL

# TECHNICAL DATA

## INFORMAÇÃO TÉCNICA

### CERTIFICATIONS PET

### CERTIFICAÇÕES PET



EN 13501 CLASS B-s1,d0  
ASTM E84 CLASS A



EXEMPLARY LEVEL EMISSION  
CRITERIA OF BREEAM



ISO 116554:  $\alpha W=0.25$  | ISO 354



EC1<sup>PLUS</sup> CLASSIFICATION  
BY EMICODE CRITERIA



OEKO-TEX®  
STANDARD 100 20230K1743



MEETS FORMALDEHYDE  
LIMIT REQUIRED BY LEED



IMO MSC.307 (88)  
ANNEX 1 PART 5



ENVIRONMENTAL PRODUCT  
DECLARATION



ASTM E2149



ISO 846



EN ISO 105 B-02: 6-7



EN ISO 105-X12: 4-5

### CERTIFICATIONS WOOD

### CERTIFICAÇÕES WOOD



ASTM E84 CLASS A  
EN 13501 CLASS B-s3,d0



NRC = 0.72\* (ISO 354:2003)



OEKO-TEX® STANDARD 100  
(testado para substâncias nocivas)



FSC® Chain of Custody Certificate

Material certificado segundo a norma BS EN 13964:2014 (Suspended Ceilings. Requirements and Test Methods).



# TECHNICAL DATA

## INFORMAÇÃO TÉCNICA

### MAIN FEATURES

### CARACTERÍSTICAS PRINCIPAIS



**RECYCLED FROM  
PET BOTTLES**  
RECICLADO A PARTIR DE  
GARRAFAS PET



**CHEMICALLY STABLE**  
QUIMICAMENTE INERTE



**ACOUSTIC INSULATOR**  
ISOLANTE ACÚSTICO



**THERMIC INSULATOR**  
ISOLANTE TÉRMICO



**EASY TO HANDLE**  
FÁCIL MANUSEAMENTO



**ODOULESS**  
INODORO



**FIRE PROOF**  
IGNÍFUGO



**IMPACT RESISTANT**  
RESISTENTE AO CHOQUE



**MOLD RESISTANT**  
ANTIFÚNGICO



**LONG LASTING**  
DURÁVEL



**ANTI-BACTERIAL**  
ANTIBACTERIANO



**FREE OF HARMFULL  
CHEMICALS**  
LIVRE DE PRODUTOS  
QUÍMICOS NOCIVOS



**ANTI-STAIN**  
ANTI-MANCHA



**ANTI-STATIC**  
ANTIESTÁTICO



**WATER PROOF**  
IMPERMEÁVEL



**EASY TO CLEAN**  
FÁCIL DE LIMPAR

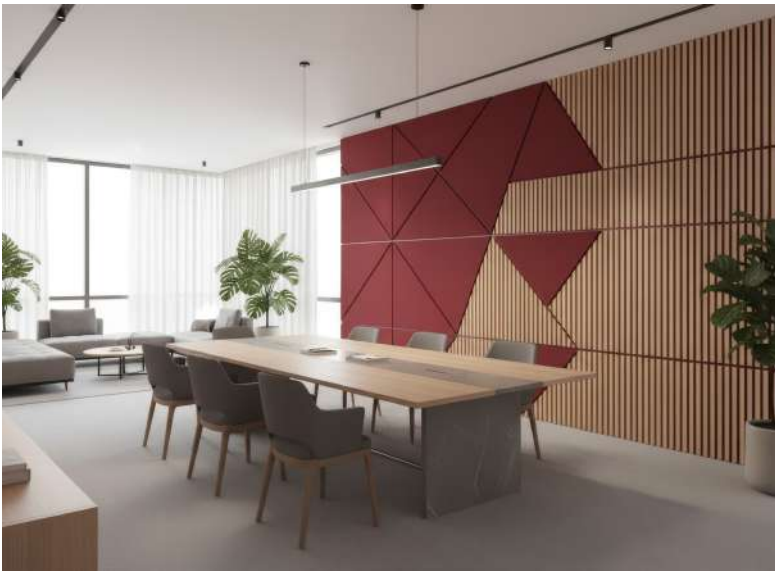



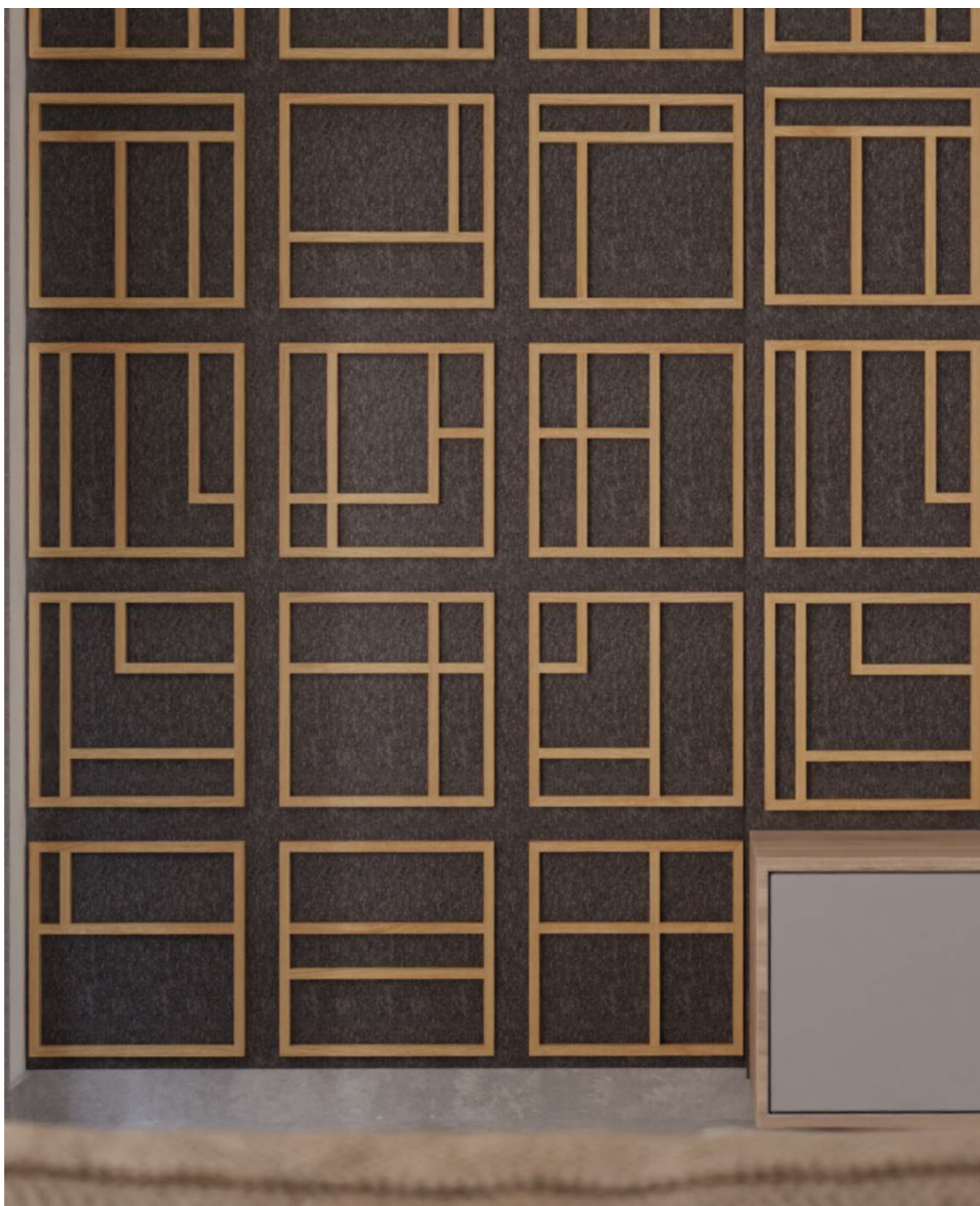

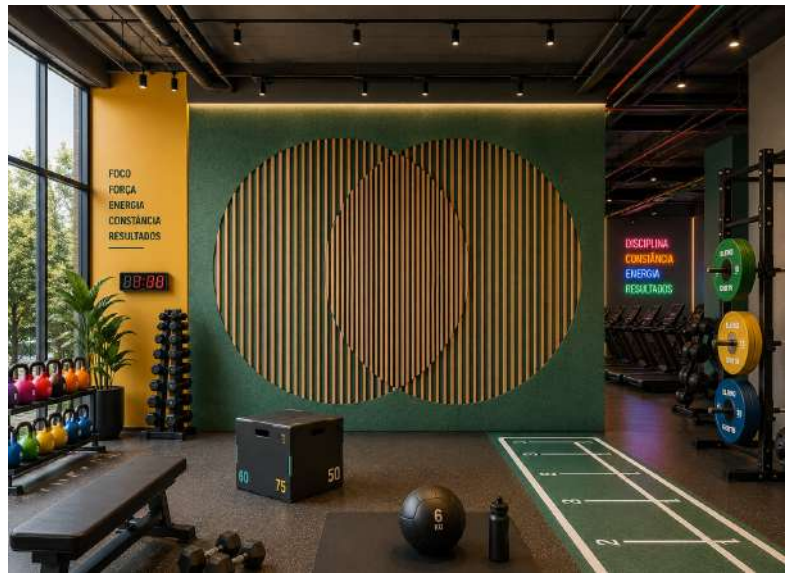

Contacts | Contactos

T.: +351 234 622 114

Custo de chamada para rede fixa nacional.

[comercial@carlosnatal.pt](mailto:comercial@carlosnatal.pt)

[www.carlosnatal.pt](http://www.carlosnatal.pt)

Parque Empresarial do Casarão

Avenida das Ferragens, 87

3750-860 Águeda, Portugal

Follow us | Siga-nos nas redes sociais

Instagram · LinkedIn · Youtube · Pinterest

© 2025 Carlos Natal, Lda. All rights reserved.

---



  
carlos natal®  
feeling beyond quality